



2022

OPHTHALMIC PRODUCTS

INSTRUMENTS | SINGLE USE | DRY EYE

SERVING
THE OPHTHALMIC
COMMUNITY FOR
OVER **40 YEARS**

Who is Stephens Instruments?

Established in 1976, Stephens Instruments has grown to become an industry-leading ophthalmic surgical instrument provider. A family-owned and operated company based in Lexington, Kentucky, USA, Stephens Instruments provides its full portfolio of **over 1000 products** to a global network of distributors in more than 60 countries around the world.

Stephens Instruments was founded on the philosophy of providing the highest quality products and unmatched customer service in the industry – all backed by an innovative design team keeping Stephens at the forefront of new surgical techniques introduced **over the past 45 years**.

Why choose Stephens?

Stephens Instruments' commitment to excellence in products and services is maintained with our certificate to ISO 13485, CE Marking, and FDA registration. Our emphasis on precision and value transfer directly to your practice with surgical instruments that will last for years to come. See why practitioners around the world have chosen Stephens Instruments and established relationships that were crafted to last a lifetime.

Lifetime Warranty

Stephens Instruments products are fully warrantied to the original owner against defects in materials and workmanship for the lifetime of the product. Any instrument with such a defect may be repaired or replaced free of charge. All unused Stephens Instruments products may be evaluated and returned for any reason during the first 30 days.

How to Order

Our team simplifies the ordering process and is here to work with you through any questions. Orders may be placed online or by contacting us through a method below:

Web: <https://stephensinst.com>

Email: info@stephensinst.com

Phone: **1-800-354-7848 or (+1)-859-259-4925**

Fax: **859-259-4926**



STEPHENS
INSTRUMENTS

Contents

Ophthalmic Reusable Instruments	3
S1 Speculums, Retractors	4
S2 Foreign Body Spuds, Alger Brush, Burrs	14
S3 Blade Breaker, Punches	17
S4 Curettes, Lens Loops, Spatulas, Manipulators, Hooks, Calipers, Phaco Choppers	18
S5 Forceps	45
S6 Needle Holders	85
S7 Scissors	91
S8 Probes & Dilators	106
S9 Markers	109
SC Cannulas	113
T Sterilization Trays	130
Titanium Reusable Instruments	132
Microsurgical Instruments	142
Instrument Sets	148
Lacriviera Punctal Plugs	187
Single-Use Instruments	200
Knives	209

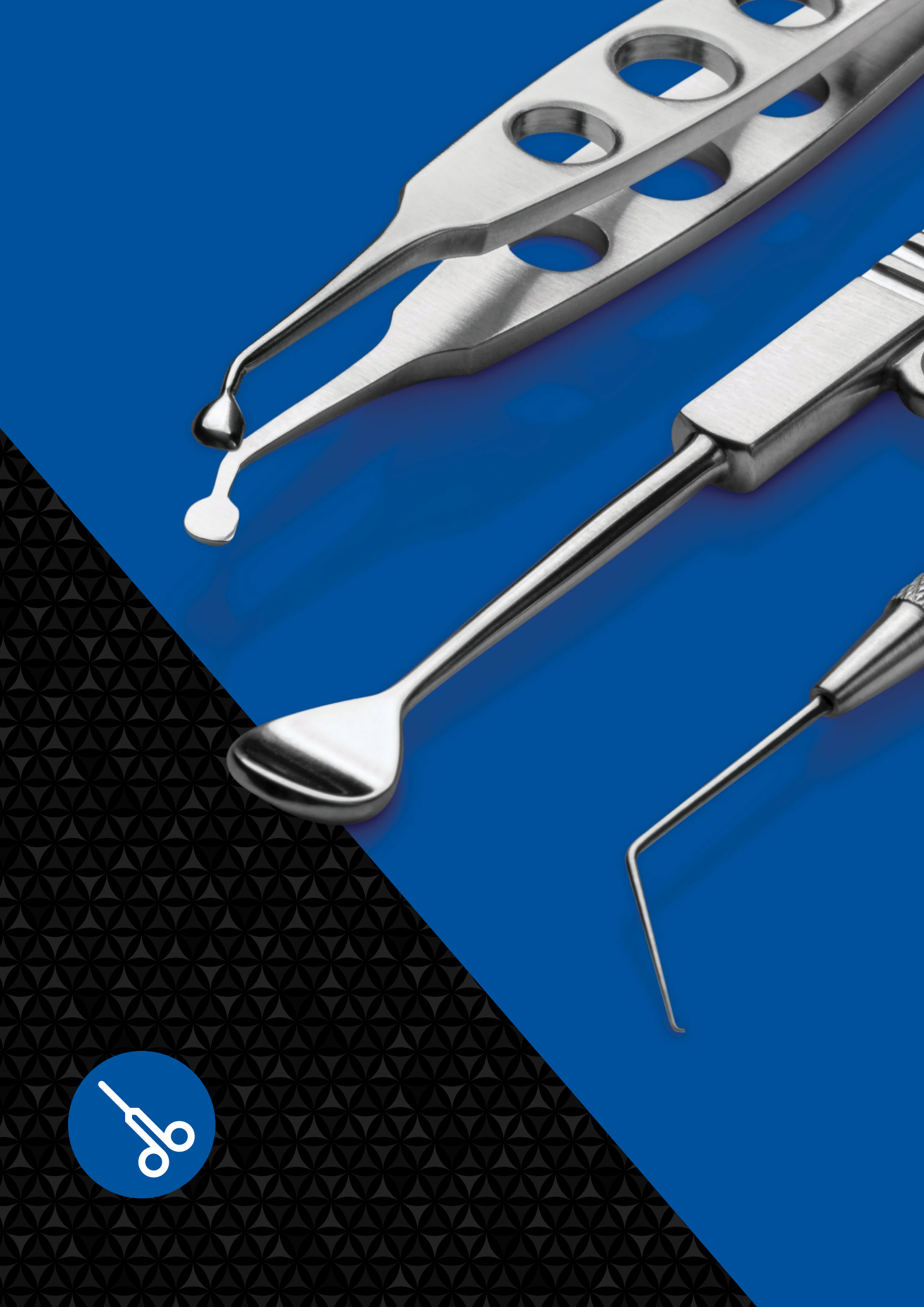

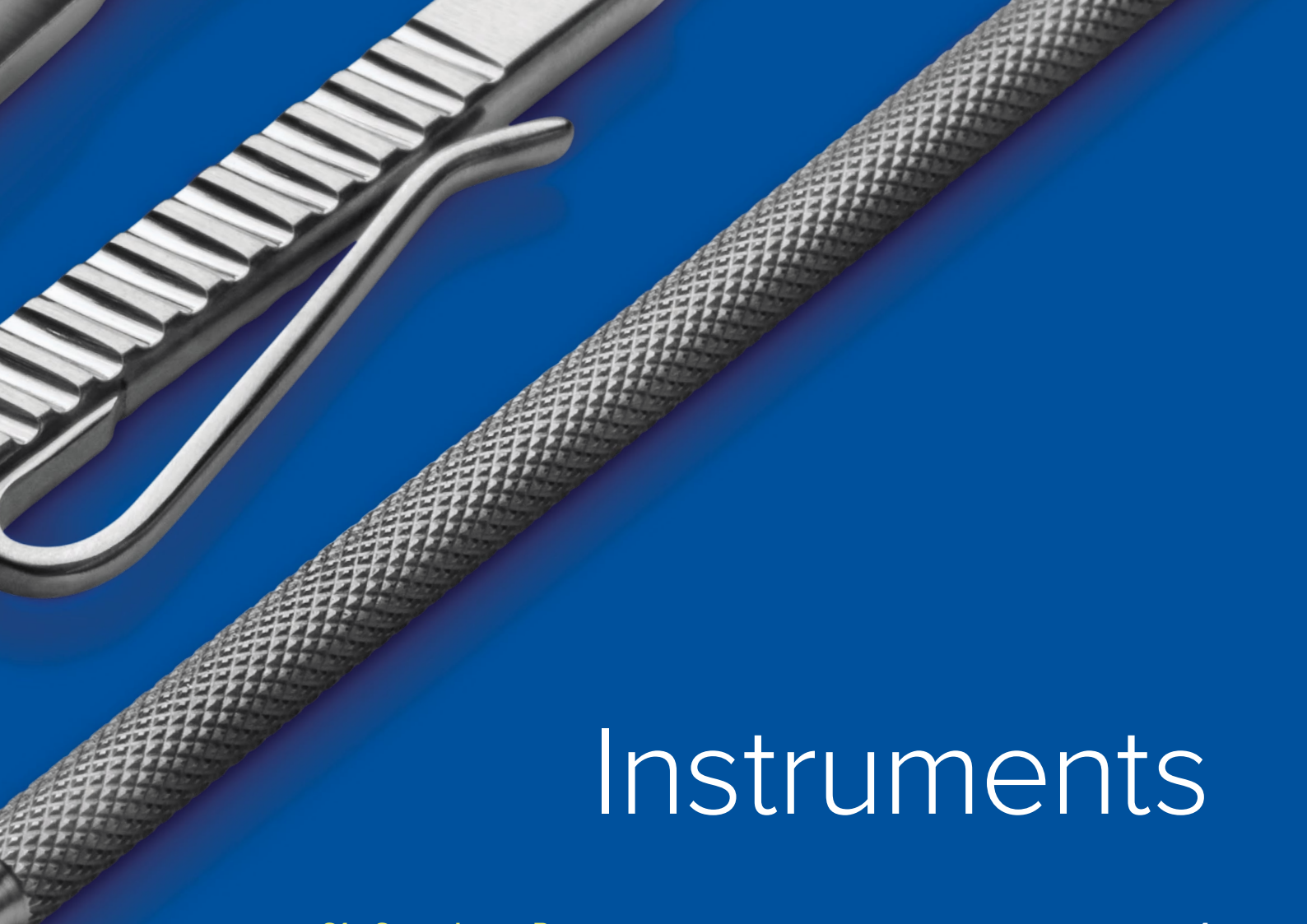

Instruments

S1	Speculums, Retractors	4
S2	Foreign Body Spuds, Alger Brush, Burrs	14
S3	Blade Breaker, Punches	17
S4	Curettes, Loops, Spatulas, Manipulators, Hooks	19
S5	Forceps	46
S6	Needle Holders	85
S7	Scissors	91
S8	Probes & Dilators	106
S9	Markers	109
SC	Cannulas	113
T	Trays	130

Newell Lid Retractor, Pair

S1-1000

Overall Length: 15mm



Barraquer Wire Speculum

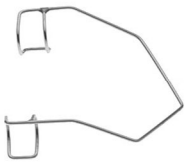

S1-1001

Infant, 4mm Blades
Overall Length: 31mm

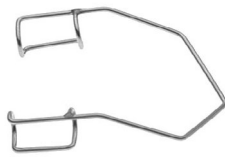

S1-1002

Child, 12mm Blades
Overall Length: 39mm

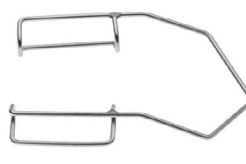

S1-1005

Adult, 15mm Blades
Overall Length: 41mm

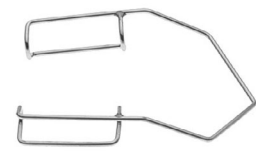

S1-1006

18mm Blades
Overall Length: 40mm

Slade LASIK Wire Speculum

S1-1003

Overall Length: 40mm

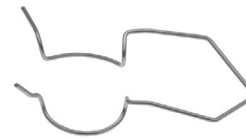

Barraquer Wire Speculum, Solid Blades



S1-1009

Infant, 4mm Blades
Overall Length: 35mm



S1-1010

Child, 12mm Blades
Overall Length: 35mm



S1-1015

Adult, 15mm Blades
Overall Length: 42mm

Barraquer Wire Speculum

Nasal Approach

S1-1011 12mm Blades

Overall Length: 39mm

S1-1012 15mm Blades

Overall Length: 42mm

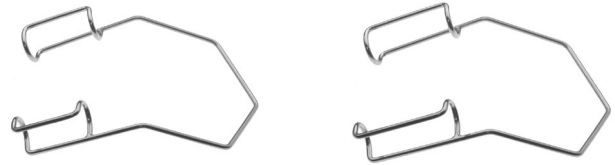

Barraquer Wire Speculum, Solid Blades

S1-1013

Overall Length: 42mm

Nasal Approach

15mm Blades



Lieberman Speculum

S1-1014K

Overall Length: 77mm

Nasal Approach

K-Wire



Lieberman Speculum

S1-1014S

Overall Length: 77mm

Nasal Approach

Solid Blade, 15mm Blades



Lieberman Speculum

S1-1014U

Overall Length: 77mm

Universal Approach

Solid Blade, 15mm Blades

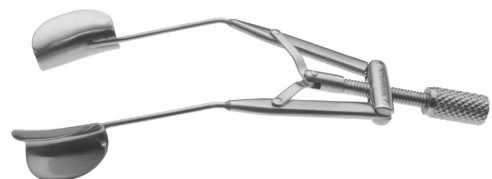

Lieberman Speculum

S1-1014V

Overall Length: 77mm

Nasal Approach

V-Wire



Kratz Wing Speculum

S1-1016

Overall Length: 38mm

Adult, 15mm Blades



Kratz Wing Speculum

S1-1018

Overall Length: 51mm

Fenestrated Blades

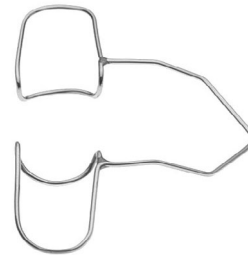

Grandon-Barraquer Speculum

S1-1020

Overall Length: 44mm

Wire Blade with Suture Notches

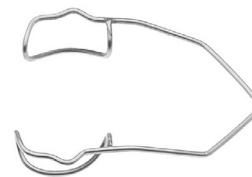

Stephens V-Shaped Wire Speculum

S1-1022

Overall Length: 47mm

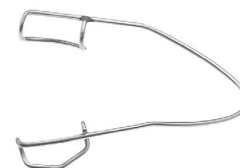

Stephens Irrigating Speculum

S1-1025

Overall Length: 86mm
 Temporal Approach
 15mm Blades

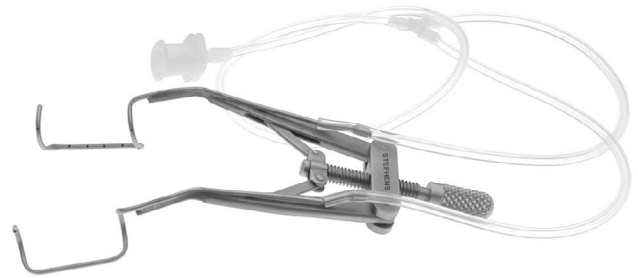

Lieberman Speculum

S1-1026

Overall Length: 82mm
 K-Wire, Temporal Approach
 15mm Blades



Lieberman Speculum

S1-1027

Overall Length: 81mm
 V-Wire, Temporal Approach
 15mm Blades



Lieberman Speculum

S1-1028

Overall Length: 78mm
 Solid Blade, Temporal Approach
 15mm Blades



Alfonzo Speculum

S1-1029

Overall Length: 44mm
 Infant, 6mm Blades



Sauer Speculum

S1-1040 Infant, 6mm Blades

Overall Length: 30mm

S1-1045 Premature, 4mm Blades

Overall Length: 26mm



Cook Speculum



S1-1052

Solid Blades, 3mm

Overall Length: 35mm



S1-1054

Solid Blades, 6mm

Overall Length: 41mm



S1-1055

Solid Blades, 8mm

Overall Length: 44mm



S1-1056

Solid Blades, 11mm

Overall Length: 45mm



S1-1057

Solid Blades, 15mm

Overall Length: 55mm

Clark Universal Speculum

S1-1060

Overall Length: 80mm

15mm Blades



Castroviejo Speculum

S1-1065

Overall Length: 90mm

Fenestrated Blades, 15mm

S1-1066

Overall Length: 94mm

Fenestrated Blades, 16.5mm



Castroviejo Eye Speculum

S1-1067

Overall Length: 100mm
18mm Blades



Lancaster Speculum

S1-1070

Overall Length: 85mm
Solid Blades, 15mm



Lester-Burch Speculum

S1-1075

Overall Length: 84mm
Solid Blades, 15mm

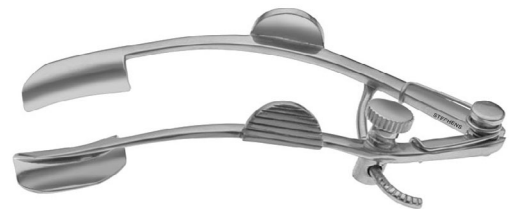

Williams Speculum

S1-1080 Child, 12mm Blades

Overall Length: 79mm

S1-1085 Adult, 15mm Blades

Overall Length: 85mm

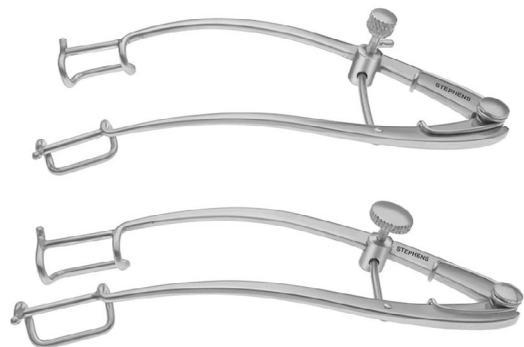

Lieberman Speculum

S1-1087

Overall Length: 67mm
Fenestrated Blades

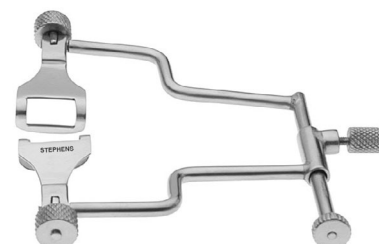

Guyton-Park Speculum



S1-1095 Overall Length: 85mm

Solid Blade

Suture Posts on Top

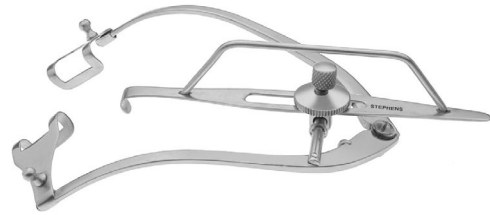

S1-1100 Overall Length: 86mm

Fenestrated Blades

Suture Posts on Top

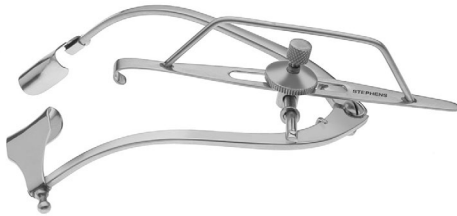

S1-1105 Overall Length: 86mm

Solid Blade

Suture Posts on Side

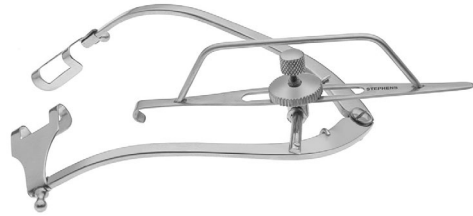

S1-1110 Overall Length: 80mm

Fenestrated Blades

Suture Posts on Side

Maumenee-Park Speculum

S1-1115

Overall Length: 57mm

Solid Blades



Maumenee-Park Speculum

S1-1120

Overall Length: 80mm

Fenestrated Blades

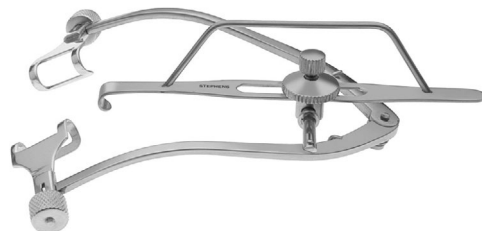

Jaffe Wire Retractor, Pair

S1-1137

Overall Length: 52mm



Flieringa Fixation Ring

S1-1155 12mm

S1-1185 18mm

S1-1160 13mm

S1-1190 19mm

S1-1165 14mm

S1-1195 20mm

S1-1170 15mm

S1-1200 21mm

S1-1175 16mm

S1-1205 22mm

S1-1180 17mm



Thornton Fixation Ring

Swinging Handle

S1-1211 Open Ring 1/4, 12mm

Overall Length: 116mm

S1-1211A Open Ring 1/2, 12mm

Overall Length: 116mm

S1-1211B Closed Ring, 14mm

Overall Length: 119mm

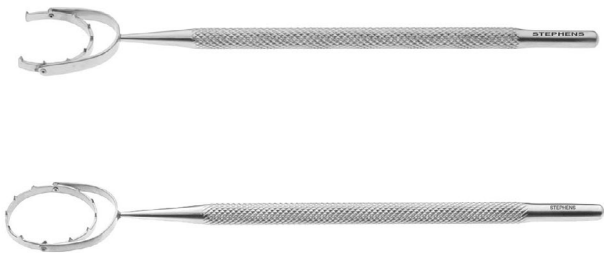

Desmarres Lid Retractor

S1-1215 #0, 11mm

Overall Length: 140mm

S1-1220 #1, 13mm

Overall Length: 143mm

S1-1225 #2, 15mm

Overall Length: 144mm

S1-1230 #3, 17mm

Overall Length: 146mm

S1-1230A Infant

Overall Length: 138mm



Jaeger Lid Plate

S1-1235

Overall Length: 107mm



Agricola Retractor

S1-1240

Overall Length: 42mm

3x3 Prongs



Goldstein Retractor

S1-1245

Overall Length: 33mm



Muller Retractor

S1-1250

Overall Length: 65mm

3x3 Prongs

Lacrimal Sac



Stevenson Retractor

S1-1255

Overall Length: 88mm

3x3 Prongs



Stevenson Retractor

S1-1260

Overall Length: 85mm

Solid Blade

Lacrimal Sac



Fink Retractor

S1-1265

Overall Length: 128mm

4 Prongs

Angled, Blunt



Knapp Retractor

S1-1270

Overall Length: 133mm

4 Prongs, Blunt



Tenzel Double Ended Periosteal Elevator

S1-1275

Overall Length: 196mm



West Lacrimal Chisel

S1-1276 Straight

Overall Length: 135mm



S1-1277 Curved

Overall Length: 126mm



Wills Retractor

S1-1280

Overall Length: 136mm

6 Prongs, Sharp



Nasal Speculum



S1-1295

Infant

Overall Length: 129mm



S1-1296

Child

Overall Length: 126mm



S1-1297

Adult

Overall Length: 128mm

Wright Fascia Needle

S1-1310

Overall Length: 136mm



Tooke Corneal Knife

S2-1100

Overall Length: 114mm



Gill Corneal Knife

S2-1115

Overall Length: 124mm

Curved



Haab Scleral Knife

S2-1120

Overall Length: 122mm

5mm Tip



Foreign Body Needle

S2-1125 Straight

Overall Length: 120mm

S2-1130 Curved

Overall Length: 120mm

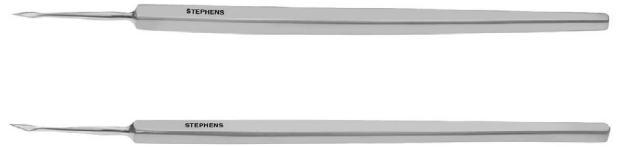

Dix Foreign Body Spud

S2-1131

Overall Length: 125mm



Golf Club Foreign Body Spud

S2-1135

Overall Length: 117mm

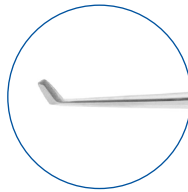

Ellis Foreign Body Spud

S2-1140

Overall Length: 116mm

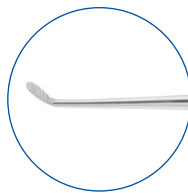

Francis Foreign Body Spud

S2-1145

Overall Length: 120mm

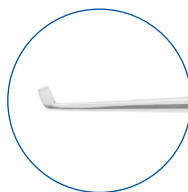

La-Force Foreign Body Spud

S2-1150

Overall Length: 120mm

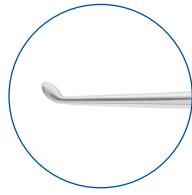

Wills Eye Foreign Body Spud & Burr

S2-1155

Overall Length: 109mm



Stephens Eye Loop & Magnet

S2-1160

Overall Length: 150mm



Alger Brush

Battery Included

S2-1170 1.0mm Tip,

S2-1171 0.5mm Tip,

S2-1175 1.0mm Tip, Burrs Only (2)

S2-1175A 0.5mm Tip, Burrs Only (2)



Pterygium Brush

Round Tip, Diamond Dusted, Battery Included

S2-1176 2.5mm, Fine Grit,

S2-1177 3.5mm, Medium Grit,

S2-1178 Tip Only, 2.5mm, Fine Grit,

S2-1179 Tip Only, 3.5mm, Medium Grit,



Castroviejo Blade Breaker

S3-1000

Overall Length: 115mm

With Lock



Castroviejo Blade Breaker

S3-1005

Overall Length: 99mm

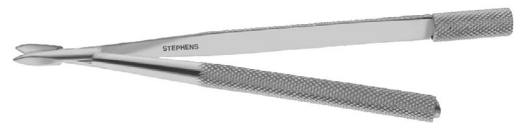

Stephens Blade Breaker

S3-1010

Overall Length: 102mm

Small Square Jaws



Swiss Blade Breaker

S3-1020

Overall Length: 120mm



Holth Capsular Punch

S3-1030 1mm

Overall Length: 95mm

S3-1030A 1.5mm

Overall Length: 88mm

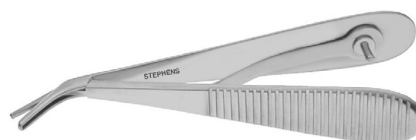

Kelly Descemet Membrane Punch

S3-1036

Overall Length: 128mm
1.0mm Punch



Reiss Corneoscleral Punch

S3-1037

Overall Length: 87mm



Gass Punch

S3-1038

Overall Length: 89mm



Meyerhoefer Chalazion Curette

S4-1000 1.5mm

Overall Length: 132mm

S4-1001 0.5mm

Overall Length: 130mm

S4-1005 #1, 1.75mm

Overall Length: 132mm

S4-1010 #2, 2.25mm

Overall Length: 132mm

S4-1015 #3, 2.50mm

Overall Length: 132mm

S4-1020 #4, 3.50mm

Overall Length: 132mm



Open Ended Curette

S4-1000A 1.5mm

Overall Length: 110mm

S4-1005A 1.75mm

Overall Length: 102mm

S4-1010A 2.25mm

Overall Length: 104mm

S4-1015A 2.5mm

Overall Length: 100mm

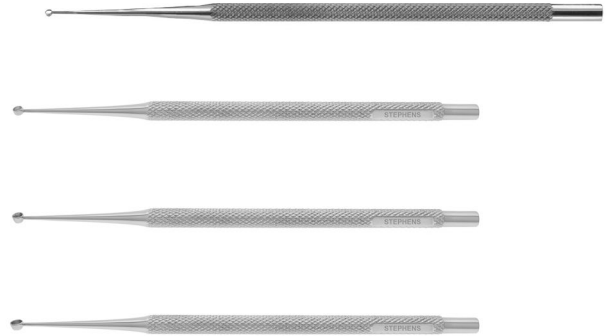

Gills-Welsh Curette

S4-1021

Overall Length: 128mm

2mm

Angled



Weaver Curette

S4-1022

Overall Length: 90mm

Serrated



Nightingale Curette

S4-1023

Overall Length: 124mm

Capsule Polishing, Semi-Sharp



Skeel Chalazion Curette

S4-1030

Overall Length: 132mm

Serrated, 1.75mm



Barraquer Iris Spatula

S4-1039

Overall Length: 85mm
15mm Angled Tip



Barraquer Iris Spatula

S4-1040 Smooth, Round

Overall Length: 124mm

S4-1045 Delicate Tip

Overall Length: 124mm



Culler Iris Spatula

S4-1055 1.0mm

Overall Length: 129mm

S4-1060 2.0mm

Overall Length: 130mm



Kirby Iris Spatula

S4-1065

Overall Length: 128mm



Gimbel Nucleus Spatula

S4-1067

Overall Length: 123mm



Drysdale Nucleus Manipulator

S4-1068

Overall Length: 111mm
Paddle Shaped

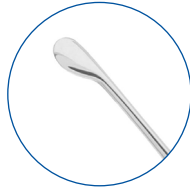

Pisacano Nucleus Rotator

S4-1069

Overall Length: 115mm

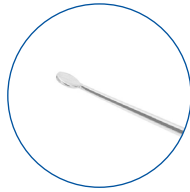

Bechert Nucleus Rotator

S4-1070

Overall Length: 110mm
Angled

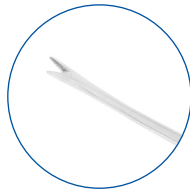

Seipser Endocapsular Controller

S4-1071

Overall Length: 116mm



Tennant Nucleus Manipulator

S4-1072

Overall Length: 115mm



Knolle Nucleus Spatula

S4-1075

Overall Length: 124mm
Flat, 0.5mm



Girard Synechia Spatula

S4-1080

Overall Length: 117mm
0.5mm, Semi-Sharp



Galin Lens Spatula

S4-1085

Overall Length: 118mm
1.5mm Angled



Koch Phaco Manipulator

S4-1089

Overall Length: 115mm

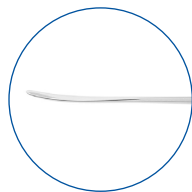

Hirschman Lens Spatula

S4-1090

Overall Length: 123mm
0.5mm, with Notches



Jaffe Lens Spatula

S4-1095

Overall Length: 122mm
0.5mm, Angled



Obstbaum Synechiae Spatula

S4-1100

Overall Length: 119mm
0.25mm



Pallin Lens Spatula

S4-1105

Overall Length: 115mm
Angled with Notch



Maumenee-Barraquer Spatula

S4-1116

Overall Length: 120mm
Vitreous, Right



Castroviejo Synechiae Spatula

0.5mm

S4-1120 Sharp

Overall Length: 139mm

S4-1125 Semi-Sharp

Overall Length: 137mm



Castroviejo Cyclodialysis Spatula

S4-1130 0.25mm

Overall Length: 142mm

S4-1135 0.50mm

Overall Length: 141mm



Castroviejo Cyclodialysis Spatula

S4-1140

Overall Length: 142mm

0.75mm Wide



Dastoor Pupil & Iris Repositor

S4-1145

Overall Length: 133mm



Elschnig Cyclodialysis Spatula

S4-1150

Overall Length: 133mm



Barraquer Lenticular Spoon

S4-1151

Overall Length: 124mm



Castroviejo Spatula & Spoon

S4-1153

Overall Length: 133mm



Paton Double Spatula

S4-1154

Overall Length: 135mm

2mm Tip



Kimura Platinum Spatula

S4-1155

Overall Length: 149mm



Gills/Welsh Lens Loop

S4-1156

Overall Length: 117mm



Lens Loop

S4-1157

Overall Length: 133mm

Fine



Morrison Lens Loop & Probe

S4-1158

Overall Length: 149mm



Lewis Lens Loop

S4-1160 Small

Overall Length: 135mm



S4-1165 Large

Overall Length: 139mm



New Orleans Lens Loop

S4-1170

Overall Length: 139mm



Kirby Intracapsular Lens Loop

S4-1171

Overall Length: 135mm



Snellen Lens Loop

S4-1175

Overall Length: 140mm



Weber Lens Loop

S4-1180

Overall Length: 140mm



Wilder Serrated Lens Loop

S4-1185

Overall Length: 140mm



Simcoe Double Lens Loop

S4-1191

Overall Length: 137mm



Bunge Evisceration Spoon

S4-1200 Small, 8mm

Overall Length: 131mm



S4-1205 Medium, 10mm

Overall Length: 139mm



S4-1210 Large, 12mm

Overall Length: 142mm



Wells Enucleation Spoon

S4-1215

Overall Length: 145mm



Arruga Retractor

S4-1220

Overall Length: 144mm
11mm Blade



Schocket Scleral Depressor

S4-1231

Overall Length: 135mm



Schepens Scleral Depressor

S4-1232

Overall Length: 49mm
Thimble



Josephberg-Besser Scleral Depressor

S4-1236 Double-Ended

Overall Length: 138mm

S4-1236S Single-Ended

Overall Length: 100mm



Schepens Orbital Retractor

S4-1260

Overall Length: 154mm



Baker Orbital Retractor Set

S4-1261

Overall Length: 155mm
Malleable (Set of 3)



Tyrell Iris Hook

S4-1270 Sharp

Overall Length: 121mm



S4-1275 Blunt

Overall Length: 124mm



Fixation Hook

Sharp

S4-1280 Small

Overall Length: 129mm



S4-1285 Large

Overall Length: 132mm



Scleral Hook

Twist Fixation

S4-1290 0.5mm, Right

Overall Length: 110mm



S4-1295 0.3mm, Right

Overall Length: 116mm



S4-1300 0.5mm, Left

Overall Length: 107mm



S4-1305 0.3mm, Left

Overall Length: 107mm



Burch Fixation Pick

S4-1310

Overall Length: 135mm



Bonn Micro Iris Hook

S4-1315

Overall Length: 125mm

Round Handle, with Guard



Bonn Micro Iris Hook

S4-1320

Overall Length: 126mm

Blunt, Flat Handle



Graether Collar Button

S4-1325 Straight

Overall Length: 119mm

S4-1326 Angled

Overall Length: 123mm

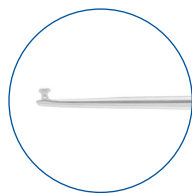

Sheets Micro Hook

S4-1330

Overall Length: 124mm

Sharp, with Guard



Knolle Micro Iris Hook

S4-1335

Overall Length: 122mm
Blunt



Mackool Iris Repositor

S4-1341

Overall Length: 112mm



Hirschman Iris Hook

S4-1345

Overall Length: 117mm
Lens Manipulator, Blunt



Kuglen Iris Hook & Lens Manipulator

S4-1360

Overall Length: 113mm
Clover Leaf, Straight

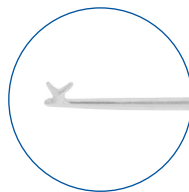

Kuglen Iris Hook

S4-1365

Overall Length: 112mm
Push-Pull Model
Straight

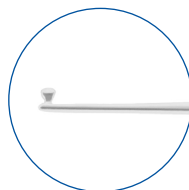

Kuglen Iris Hook

S4-1370

Overall Length: 111mm

Push-Pull Model

Angled

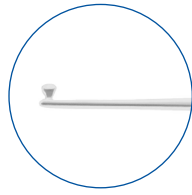

Grayson/Kuglen Double-Ended Manipulator

S4-1369

Overall Length: 137mm

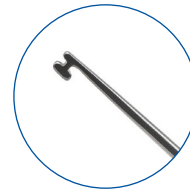

Lester Lens Manipulator

S4-1371 Straight

Overall Length: 116mm

S4-1372 Angled

Overall Length: 114mm

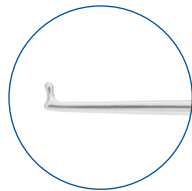

Fenzl Lens Manipulating Hook

S4-1373 Straight

Overall Length: 114mm

S4-1374 Angled

Overall Length: 116mm

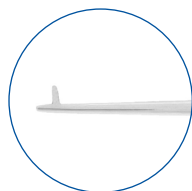

Fenzl Lens Manipulator

S4-1374A

Overall Length: 118mm
Angled Forward



Harris-Sinskey Lens Hook

S4-1375

Overall Length: 116mm
Angled, Blunt



Lewicky Lens Manipulating Hook

S4-1376

Overall Length: 117mm
0.15mm Tip
Curved

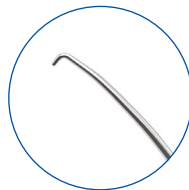

Rainin Lens Hook

S4-1380

Overall Length: 125mm
Blunt

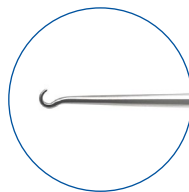

Fugo Z-Hook Lens Manipulator

S4-1381

Overall Length: 114mm

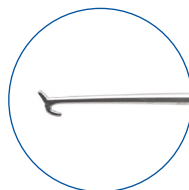

Rentsch & Boat Hook & Lens Manipulator

S4-1382

Overall Length: 114mm

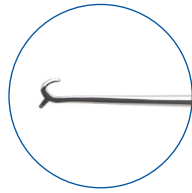

Maltzman-Fenzl Lens Manipulator Hook

V-Shaped

S4-1383 Straight

Overall Length: 118mm

S4-1384 Angled

Overall Length: 117mm

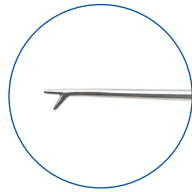

Sinsky Micro Lens Hook

S4-1385

Overall Length: 117mm

90 Degree

Angled for Shearing

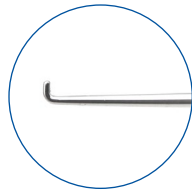

Sinsky II Lens Hook

0.18mm Tip

S4-1386 Straight

Overall Length: 112mm

S4-1387 Angled

Overall Length: 111mm

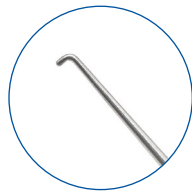

Sinsky II Lens Manipulating Hook

S4-1390

Overall Length: 116mm

For A/C Lenses

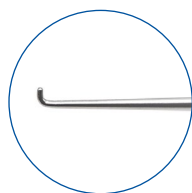

Galand Lens Manipulating Hook

S4-1391

Overall Length: 117mm



Jaffe-Maltzman Lens Hook

S4-1392

Overall Length: 116mm
Angled, V-Shaped

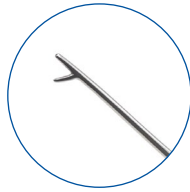

Osher Y-Hook IOL Manipulator

S4-1393

Overall Length: 119mm
Straight

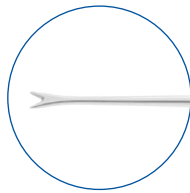

Tennant Manipulating Hook

S4-1395

Overall Length: 120mm
For A/C Lenses

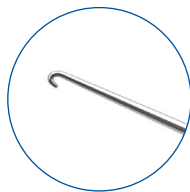

Stephens Phaco Nucleus Splitter

S4-1396

Overall Length: 115mm



Osher Nucleus Splitter

S4-1396M

Overall Length: 116mm



Reverse Sinskey Hook

S4-1397

Overall Length: 119mm

DSEK



O'Conner Tenotomy Hook

S4-1400

Overall Length: 129mm



Stevens Tenotomy Hook

S4-1405

Overall Length: 121mm



Graefe Muscle Hook

S4-1410 #3, Large

Overall Length: 141mm

S4-1415 #2, Medium

Overall Length: 140mm

S4-1420 #1, Small

Overall Length: 134mm



Culler Rectus Muscle Hook

S4-1425

Overall Length: 123mm



Jameson Muscle Hook

S4-1430 Small, 10mm

Overall Length: 129mm



S4-1435 Large, 12mm

Overall Length: 134mm



Kirby Expressor Hook & Loop

S4-1439

Overall Length: 141mm

5mm Diameter



Kirby Muscle Hook

S4-1440

Overall Length: 134mm



Kirby Muscle Hook

S4-1441

Overall Length: 134mm

Double-Ended



McCreynolds Spatula & Hook

S4-1442

Overall Length: 128mm



Strabismus Hook

S4-1443

Overall Length: 149mm



Green Muscle Hook

S4-1445

Overall Length: 130mm



Green Spatula

S4-1446

Overall Length: 125mm

Double-Ended



Manson Double Ended Hook

S4-1448

Overall Length: 126mm



Mccannel Iris Suture Needle Guide

S4-1450

Overall Length: 112mm



Bonn Iris Hook

S4-1453

Overall Length: 118mm
Delicate

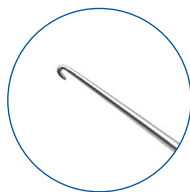

Castroviejo Caliper

S4-1455

Overall Length: 85mm
Straight, 20mm

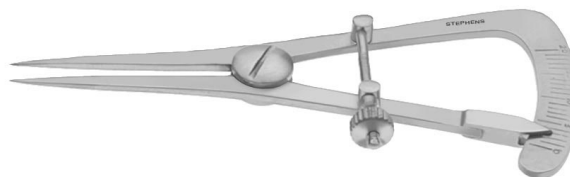

Castroviejo Caliper

S4-1456

Overall Length: 82mm
Curved, 20mm



Braunstein Caliper

S4-1457

Overall Length: 67mm
3.5mm / 4.0mm



Stainless Steel Ruler

S4-1490

Overall Length: 150mm
0.5mm Marking

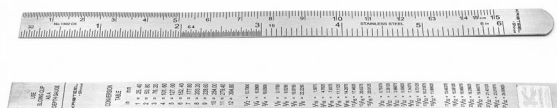

Kansas Nucleus Bisector

S4-1535

Overall Length: 112mm



Kansas Nucleus Trisector

S4-1540

Overall Length: 110mm



Nagahara Horizontal Chopper

S4-1550

Overall Length: 112mm



Nichamin Quick Chop Verticle Chopper

S4-1551

Overall Length: 112mm

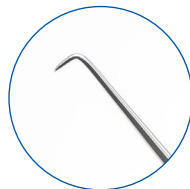

Koch Stop And Chop Manipulator

S4-1552

Overall Length: 113mm

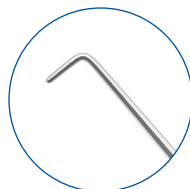

He Hook Chopper

S4-1553

Overall Length: 112mm

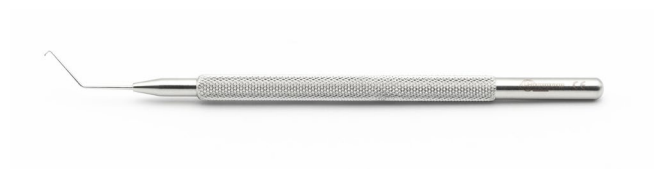
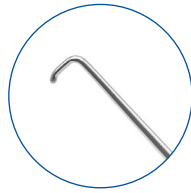

Chang-Seibel Chopper

S4-1554

Overall Length: 136mm

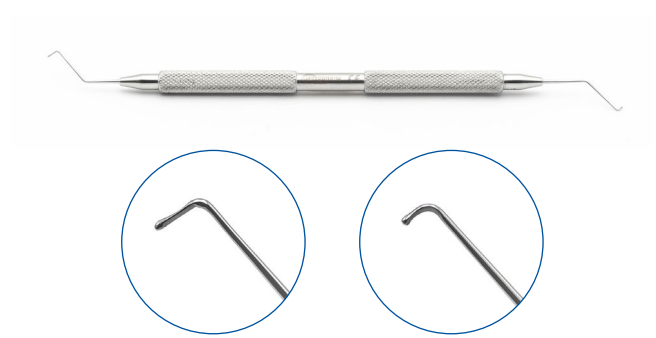

Rosen Phaco Splitter

S4-1556

Overall Length: 113mm

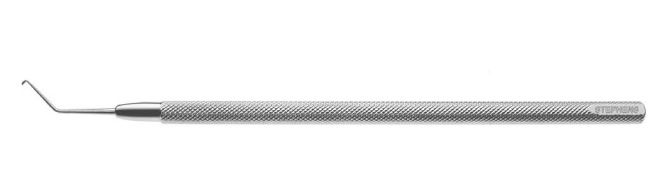
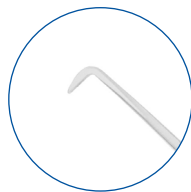

Seibel Nucleus Chopper

S4-1557

Overall Length: 117mm

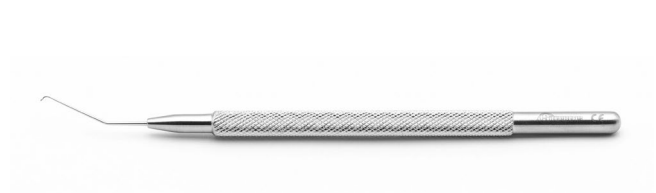

Chang Combination Microfinger Horizontal & Quick Chop

S4-1558

Overall Length: 140mm

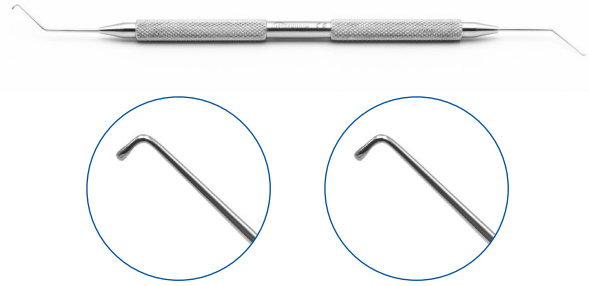

Chang Horizontal Microfinger Chopper

S4-1559

Overall Length: 112mm



Connor Wand

S4-1560 Straight

Overall Length: 117mm

S4-1565 Curved

Overall Length: 117mm



Anis Ball Tip Manipulator

S4-1570

Overall Length: 115mm



Guimaraes LASIK Spatula

S4-1600

Overall Length: 118mm



Fukasaku Lasik Spatula

S4-1605

Overall Length: 117mm



Seibel Intralase Separator-Elevator

S4-1609

Overall Length: 112mm



Slade Flap Spatula, Blunt

S4-1610

Overall Length: 131mm



Slade LASIK Retreatment

S4-1615

Overall Length: 123mm



Herzing LASIK Elevator/Retractor

S4-1620

Overall Length: 147mm



KU LASIK Flap Elevator/Manipulator

S4-1625

Overall Length: 128mm



Machat LASIK Retreatment

S4-1630

Overall Length: 124mm



Osher Utility Hook

S4-1640

Overall Length: 116mm

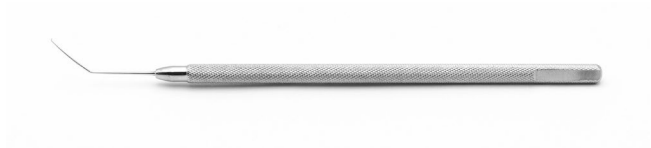
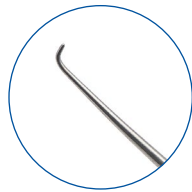

Buratto Flap Protector

S4-1660

Overall Length: 114mm



Katzen LASIK Flap Unzipper

S4-1665

Overall Length: 112mm

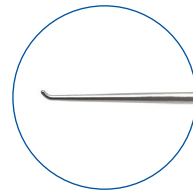
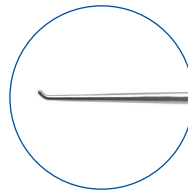

Endothelial Stripper

S4-1670

Overall Length: 124mm

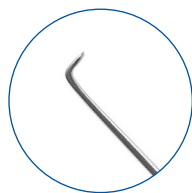

Corneal Epithelium Spatula-Hockey Stick

S4-1675

Overall Length: 123mm



Double Ended Femtosecond Spatula

S4-1700

Overall Length: 141mm



Solomon Femto Chopper

S4-1710

Overall Length: 114mm



SMILE Double Ended Dissector

S4-1715

Overall Length: 127mm

Lenticle Manipulator

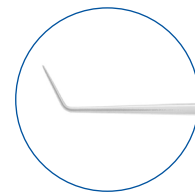
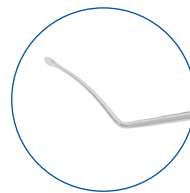

Seibel II

S4-1720

Overall Length: 103mm

Intralase Flap Lifter & Retreatment Spatula



Ayer Chalazion Forceps

S5-1000 With Screw

Overall Length: 92mm

S5-1005 Without Screw

Overall Length: 91mm



Baird Chalazion Forceps

S5-1010

Overall Length: 96mm



Dolmetsch Ptosis Clamp

S5-1014

Overall Length: 100mm



Berke Ptosis Forceps

S5-1015 20mm Jaws

Overall Length: 99mm

S5-1016 27mm Jaws

Overall Length: 101mm



Entropian Forceps

S5-1017 Right

Overall Length: 101mm

S5-1018 Left

Overall Length: 101mm



Cauer Chalazion Forceps

S5-1020

Overall Length: 96mm
with Serrations



Desmarres Chalazion Forceps

S5-1025 20mm

Overall Length: 91mm

S5-1030 26mm

Overall Length: 95mm

S5-1035 30mm

Overall Length: 101mm



Erhardt Lid Forceps

S5-1040

Overall Length: 96mm

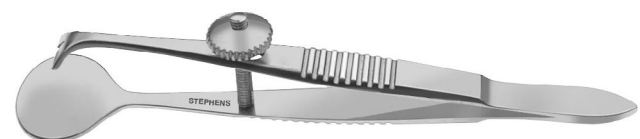

Francis Chalazion Forceps

S5-1045

Overall Length: 96mm
12x14mm



Heath Chalazion Forceps

S5-1050

Overall Length: 99mm
12x14mm



Hunt Chalazion Forceps

S5-1055

Overall Length: 92mm
12mm

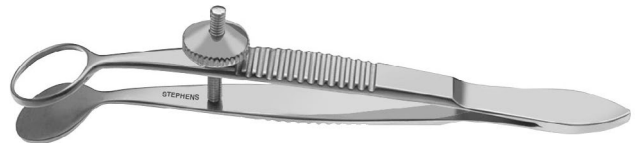

Lacriviera Meibomian Gland Expressor

S5-1057

Overall Length: 92mm



Stephens Meibomian Gland Expressor

S5-1058

Overall Length: 102mm
Paddle Width: 3.25mm



Stephens Intracanalicular Plug Forceps

S5-1059

Overall Length: 111mm

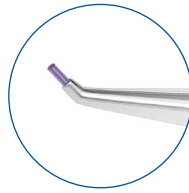

Lambert Chalazion Forceps

S5-1060 Small, 8mm

Overall Length: 91mm

S5-1065 Large, 11mm

Overall Length: 95mm

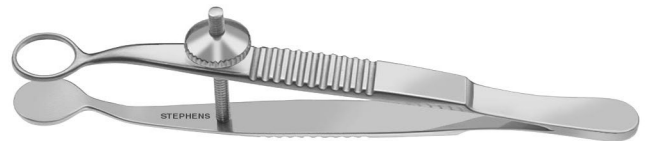

Lordan Chalazion Forceps

S5-1070

Overall Length: 93mm



Lahey Chalazion Forceps

S5-1075

Overall Length: 100mm

With Teeth



Wiese Chalazion Forceps

S5-1080

Overall Length: 96mm

Serrated Jaws



Barraquer Cilia Forceps

S5-1085

Overall Length: 108mm

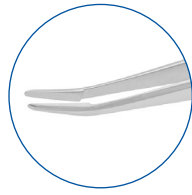

Stephens Cilia Forceps

S5-1086

Overall Length: 87mm



Beaupre Cilia Forceps

S5-1090

Overall Length: 113mm



Stephens Cilia Forceps

S5-1095 1mm

Overall Length: 81mm

S5-1100 2mm

Overall Length: 82mm

S5-1105 3mm

Overall Length: 82mm



Gradle Cilia Forceps

S5-1110

Overall Length: 100mm



Barraquer Colibri Forceps

S5-1120

Overall Length: 70mm
Tying Platform
0.12mm

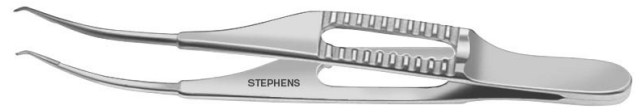
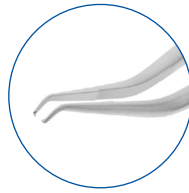

Colibri Forceps

S5-1125

Overall Length: 75mm
45 Degree Angled
0.12mm

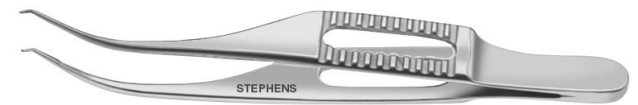
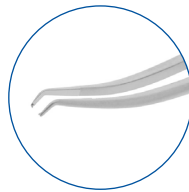

Colibri Forceps

S5-1130

Overall Length: 73mm
0.1mm Teeth
Straight

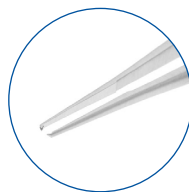

Gills Colibri Forceps

S5-1131

Overall Length: 72mm
Fine Tip

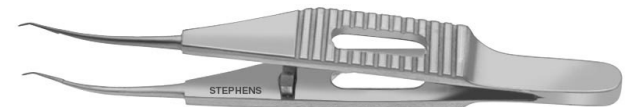
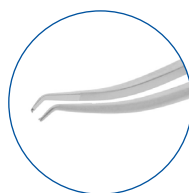

Colibri Forceps

S5-1135

Overall Length: 74mm
Tying Platform
0.4mm

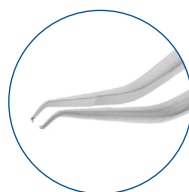

Colibri Forceps**S5-1140**

Overall Length: 102mm
 Round Handle
 0.12mm

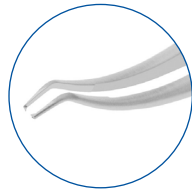
**Castroviejo Colibri Forceps****S5-1145**

Overall Length: 107mm
 Tying Platform
 0.12mm

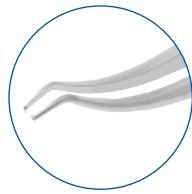
**Harms Colibri Forceps****S5-1150**

Overall Length: 73mm
 Tying Platform
 0.12mm

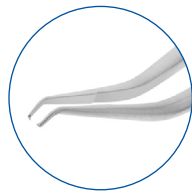
**Colibri Forceps****S5-1155**

Overall Length: 101mm
 Tying Platform
 Set at 45deg
 0.12mm

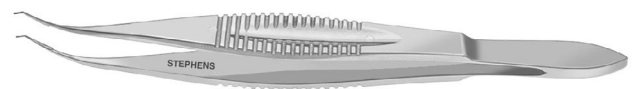
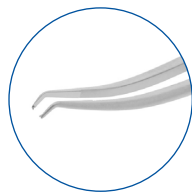
**Maumenee Colibri Forceps****S5-1160**

Overall Length: 117mm
 90 Degree Angled
 0.1mm

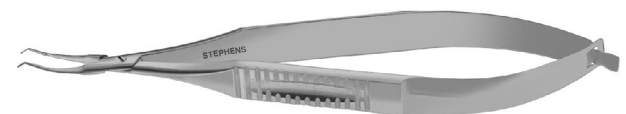
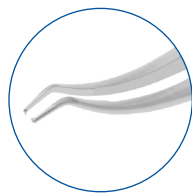

Maumenee Colibri Forceps

S5-1161

Overall Length: 119mm

0.1mm Teeth

Set at 45deg

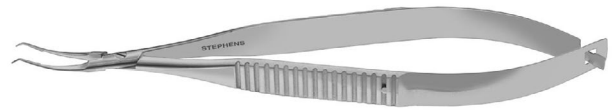
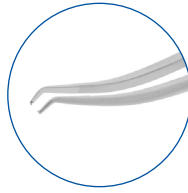

Pierse Colibri Forceps

S5-1165

Overall Length: 72mm

Tying Platform

0.1mm

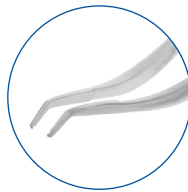

Tennant Colibri Forceps

S5-1175

Overall Length: 121mm

Tying Platform

1x2 Teeth, 0.12mm

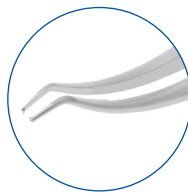

Stephens Corneal Forceps

S5-1176

Overall Length: 126mm

Pierse Hole behind Teeth

1x2 Teeth

0.12mm



Troutman-Barraquer Colibri Forceps

S5-1180

Overall Length: 72mm

Tying Platform

0.12mm

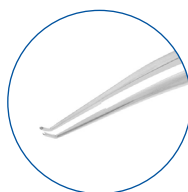

Girard Corneoscleral Forceps

1x2 Teeth, 0.12mm

S5-1185 Right

Overall Length: 101mm

S5-1190 Left

Overall Length: 101mm

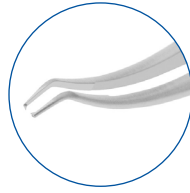

Hyde Corneal Forceps

S5-1195

Overall Length: 100mm

2x2 Teeth, 0.12mm

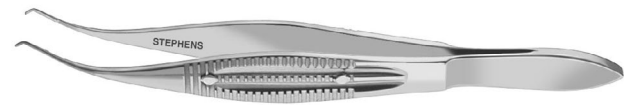
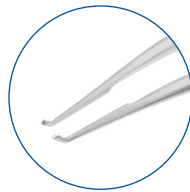

Stevens Corneoscleral Forceps

S5-1193

Overall Length: 104mm

1x2 Teeth

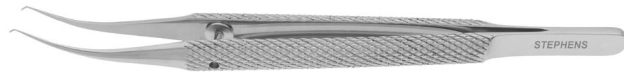
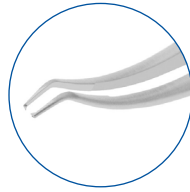

Pierse Corneal Forceps

0.1mm

S5-1200 Straight, Delicate

Overall Length: 109mm

S5-1205 Curved

Overall Length: 107mm

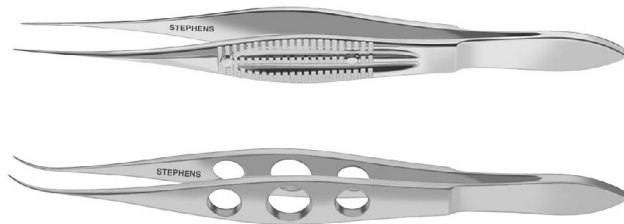
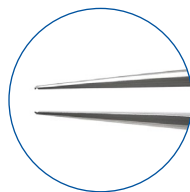

Cohan Corneal Forceps

S5-1210

Overall Length: 64mm

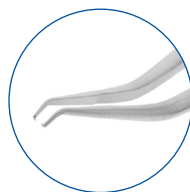

Hoffer-McPherson Corneal Forceps

S5-1215

Overall Length: 104mm

1x2 Teeth, 0.12mm

Angled

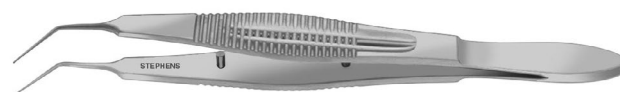
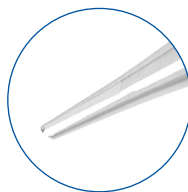

Kelman-McPherson Forceps

S5-1220

Overall Length: 104mm

1x2 Teeth, 0.3mm

Angled

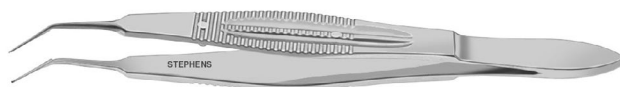
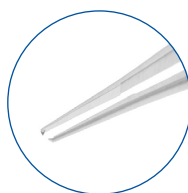

McPherson Corneal Forceps

1x2 Teeth, 0.4mm

S5-1225 Straight

Overall Length: 108mm

S5-1230 Angled

Overall Length: 107mm

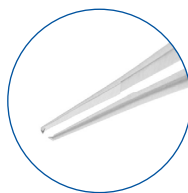

Thorpe Corneal Forceps

S5-1235

Overall Length: 108mm

2x3 Teeth, 0.12mm



DMEK Endothelium Forceps

S5-1236

Overall Length: 100mm

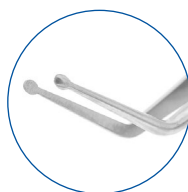

Bonn Forceps

1x2 Teeth, 0.12mm

S5-1240 Long Model

Overall Length: 109mm

S5-1245 Short Model

Overall Length: 83mm

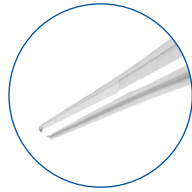
**Bonn Forceps**

Serrated Jaws

S5-1250 Straight

Overall Length: 75mm

S5-1255 Angled

Overall Length: 75mm

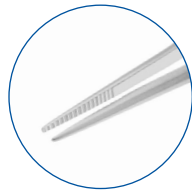
**Bonn Forceps**

1x2 Teeth, 0.12mm

S5-1260 Straight

Overall Length: 76mm

S5-1265 Angled

Overall Length: 72mm

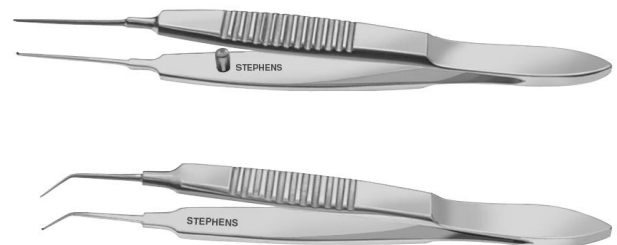
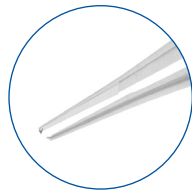
**Bonn Forceps****S5-1270**

Overall Length: 95mm

1x2 Teeth, 0.12mm

Tying Platform

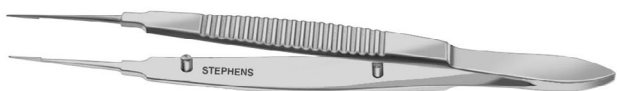
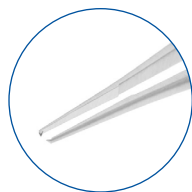

Graefe Iris Forceps

S5-1266

Overall Length: 72mm
1x2 Teeth

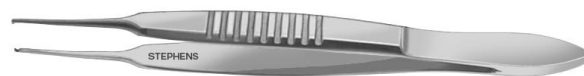
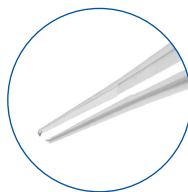

Graefe Iris Forceps

S5-1267

Overall Length: 73mm
Serrated, Curved

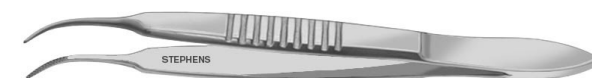
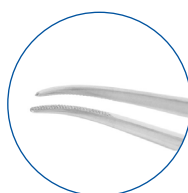

Botvin Forceps

S5-1275

Overall Length: 71mm
1x2 Teeth

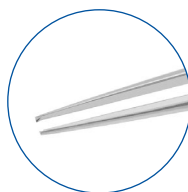

Gill Iris Forceps

Curved

S5-1285 1x2 Teeth

Overall Length: 75mm

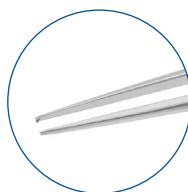

S5-1290 Serrated Jaws

Overall Length: 71mm

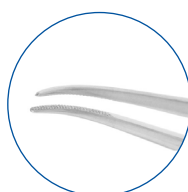

Iris Forceps**S5-1295**

Overall Length: 70mm
Serrated, Straight

**Iris Forceps****S5-1300**

Overall Length: 73mm
Serrated Jaws
Curved

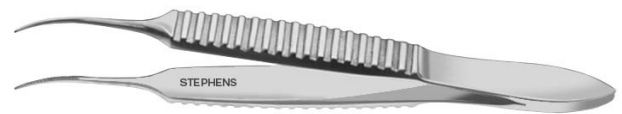
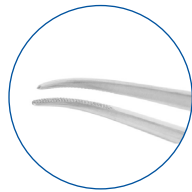
**Iris Forceps****S5-1305**

Overall Length: 95mm
Fine Teeth, Long Handle

**Iris Forceps****S5-1315**

Overall Length: 90mm
Fine Teeth, Long Handle
Long Curve

**Hess Iris Forceps****S5-1325**

Overall Length: 93mm
1x2 Teeth



Iris Forceps

S5-1330

Overall Length: 74mm
1x2 Teeth
0.1mm

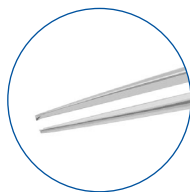

Bishop-Harmon Iris Forceps

S5-1340

Overall Length: 83mm
Criss-Cross Serrated

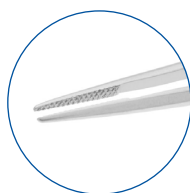

Fischer-Arlt Iris Forceps

S5-1345

Overall Length: 61mm
1x2 Teeth

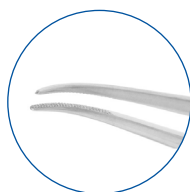

Macgregor Conjunctiva Forceps

S5-1355

Overall Length: 107mm
Tying Platform
Serrated

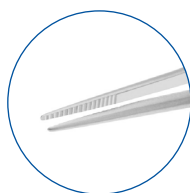

Barraquer Conjunctiva Forceps

S5-1360

Overall Length: 75mm
Tying Platform
Serrated

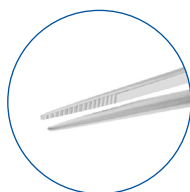

Bishop-Harmon Forceps

1x2 Teeth

S5-1365 Standard, 0.8mm

Overall Length: 85mm

S5-1370 Fine, 0.3mm

Overall Length: 84mm

S5-1371 Delicate, 0.12mm

Overall Length: 84mm

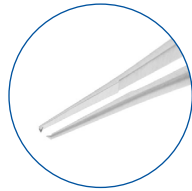
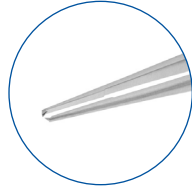
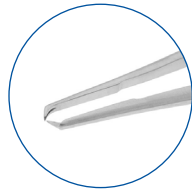

Dressing Forceps

Serrated, w/ Guide Pin

S5-1375 Straight

Overall Length: 98mm

S5-1380 Curved

Overall Length: 100mm

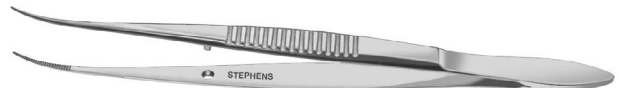
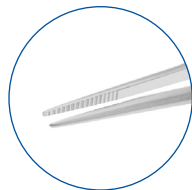

Dressing Forceps

S5-1381

Overall Length: 96mm

Serrated w/ Guide Pin

Strong Curve

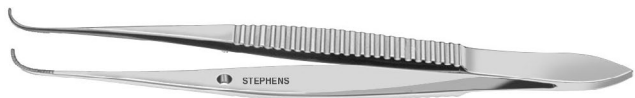

Adson Forceps

S5-1382

Overall Length: 117mm

1x2 Teeth

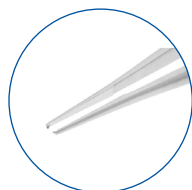

Tissue Forceps

S5-1385

Overall Length: 98mm
1x2 Teeth, Straight

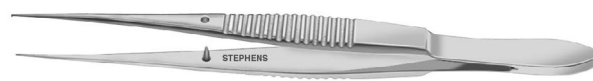
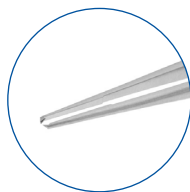

Tissue Forceps

S5-1390

Overall Length: 97mm
1x2 Teeth
Curved

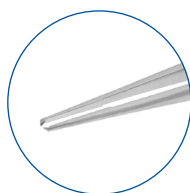

Jervey Iris Forceps

S5-1395

Overall Length: 106mm
Micro Cups
Curved

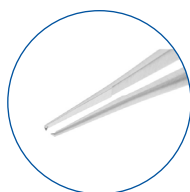

Graefe Fixation Forceps

S5-1400 4.5mm Jaws

Overall Length: 107mm

S5-1405 4.5mm Jaws, with Lock

Overall Length: 111mm

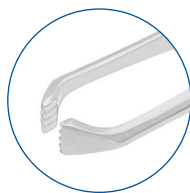

Moody Fixation Forceps

0.5mm Teeth, with Lock

S5-1410 Right

Overall Length: 105mm

S5-1415 Left

Overall Length: 105mm



Green Fixation Forceps

S5-1420 10mm Jaws, with Lock

Overall Length: 106mm

S5-1425 10mm Jaws, without Lock

Overall Length: 101mm

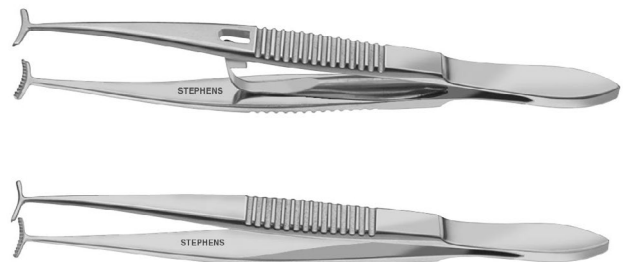

Kuhnt Fixation Forceps

S5-1430

Overall Length: 109mm

Guide Pin

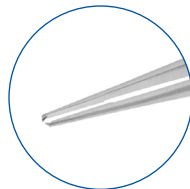

Lester Fixation Forceps

0.6mm

S5-1435 1x2 Teeth

Overall Length: 98mm

S5-1440 2x3 Teeth

Overall Length: 95mm

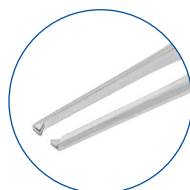
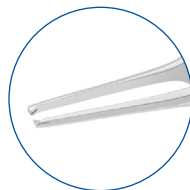

Hoffer-McPherson Corneal Bi-Fixation Forceps

S5-1443

Overall Length: 79mm
 2 Sets of 1x2 Teeth, 0.12mm
 Gills Handle

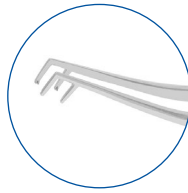

Hoffman-Polack Corneal Bi-Fixation Forceps

S5-1444

Overall Length: 105mm
 2 sets of 1x2 Teeth, 2mm Apart
 0.12mm



Elschnig Fixation Forceps

S5-1445

Overall Length: 109mm
 1x2 Teeth

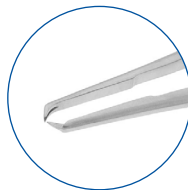

Thorpe Fixation Forceps

S5-1446

Overall Length: 95mm
 2x3 Teeth, 0.12mm

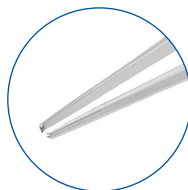

Stephens Bi-Fixation Forceps

S5-1447 0.12mm Teeth on Both Tips

8mm Apart, with Lock
 Overall Length: 110mm



S5-1447M Cross-Action

Overall Length: 108mm



Bores U-Shaped Fixation Forceps

1x2 Teeth, 0.12mm

S5-1449 Curved

3mm Spread

Overall Length: 107mm

S5-1450 Straight

3mm Spread

Overall Length: 104mm



Bracken Scleral-Fixation Forceps

S5-1451

Overall Length: 98mm

0.7mm Teeth

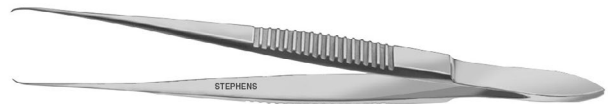
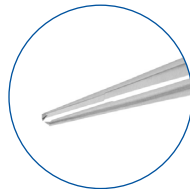

Stephens Bi-Fixation Forceps

0.12mm Teeth on Both Tips

S5-1453 Straight

13mm Spread

Overall Length: 114mm

S5-1454 Angled

13mm Spread

Overall Length: 110mm



Arruga Capsular Forceps

S5-1455

Overall Length: 102mm

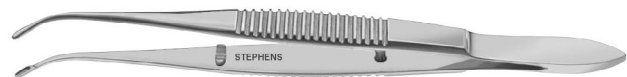
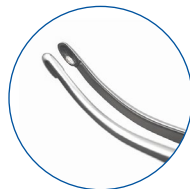

Castroviejo Capsular Forceps

S5-1470

Overall Length: 101mm
Cross-Action



Osher Superior Rectus Forceps

S5-1514

Overall Length: 98mm

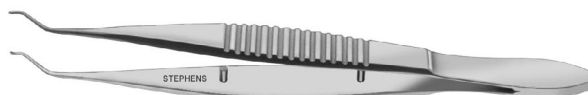
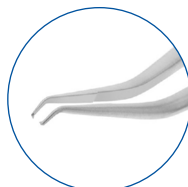

Troutman Superior Rectus Forceps

S5-1515

Overall Length: 108mm
1x2 Teeth, Angled

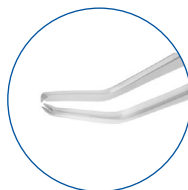

Dastoor Superior Rectus Forceps

S5-1516

Overall Length: 101mm

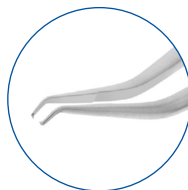

Buratto LASIK Flap Forceps

S5-1520

Overall Length: 110mm

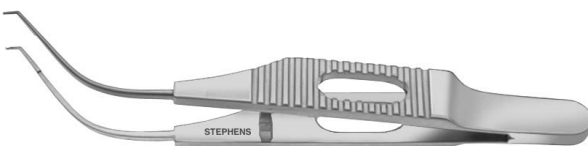
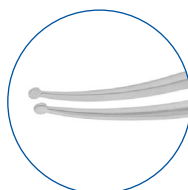

Mendez LASIK Flap Forceps**S5-1525**

Overall Length: 111mm

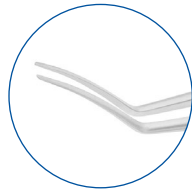
**Scleral Plug Forceps****S5-1530**

Overall Length: 105mm

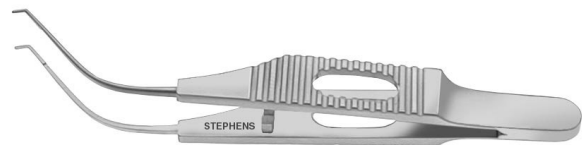
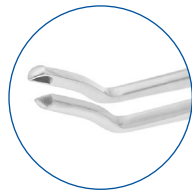
**Femto LRI Enhancement Forceps****S5-1535**

Overall Length: 109mm

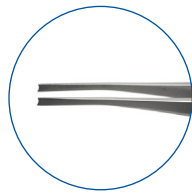
**Bock Suture Forceps****S5-1550**

Overall Length: 100mm

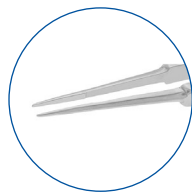
**Suture Forceps****S5-1555**

Overall Length: 98mm

Tying Platform, Curved

Round Handle

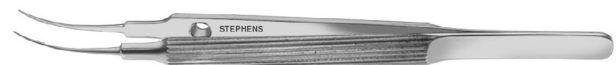
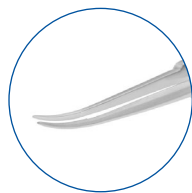

Castroviejo Suturing Forceps

Tying Platform

- S5-1560** 0.12mm, Overall Length: 105mm
- S5-1565** 0.2mm, Overall Length: 111mm
- S5-1570** 0.3mm, Overall Length: 106mm
- S5-1575** 0.5mm, Overall Length: 106mm
- S5-1580** 0.9mm, Overall Length: 113mm
- S5-1585** 1.5mm, Overall Length: 110mm

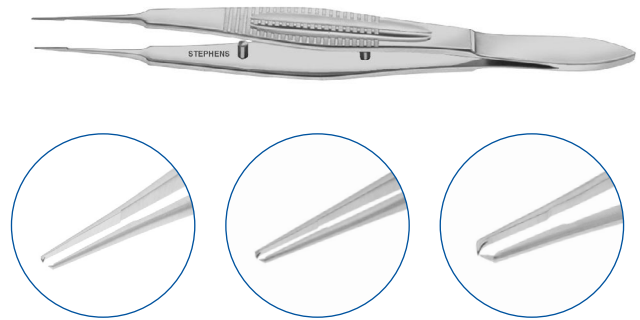

Castroviejo Suturing Forceps

Tying Platform, With Lock

- S5-1561** 0.12mm, Overall Length: 112mm
- S5-1571** 0.3mm, Overall Length: 107mm
- S5-1576** 0.5mm, Overall Length: 109mm

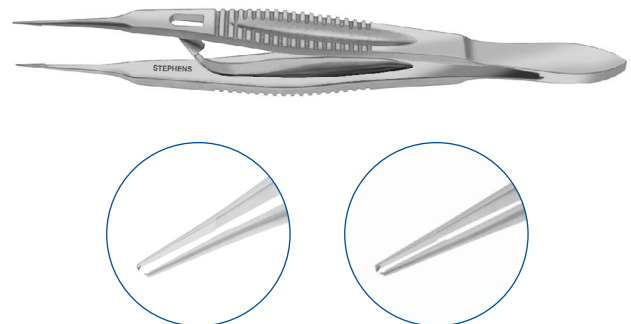

Castroviejo Suturing Forceps

Tying Platform, Angled

- S5-1590** 0.3mm
Overall Length: 106mm
- S5-1595** 0.5mm
Overall Length: 107mm

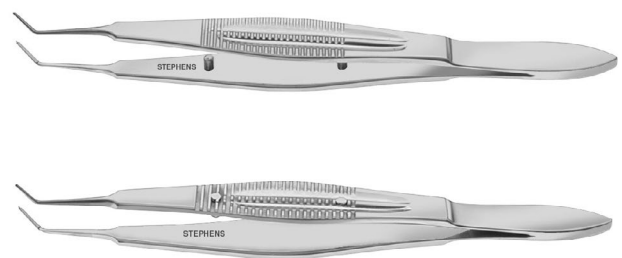
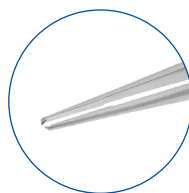

Castroviejo-Snider Forceps

- S5-1600**
Overall Length: 110mm
1x2 Teeth, 0.12mm
Tying Platform

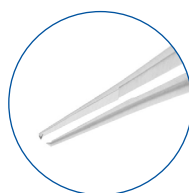

Utrata Capsulorhexis Forceps

S5-1601

Overall Length: 104mm
Round Handle

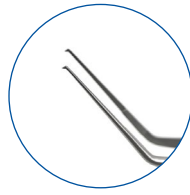

Masket Capsulorhexis Forceps

S5-1602

Overall Length: 105mm
Flat Handle

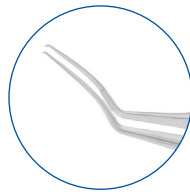

Utrata Capsulorhexis Forceps

S5-1603

Overall Length: 105mm
Flat Handle

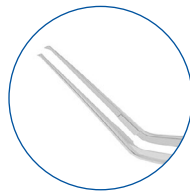

Kraf Capsule Tag Forceps

S5-1604

Overall Length: 107mm
11mm Jaws, Angled
Tying Platform

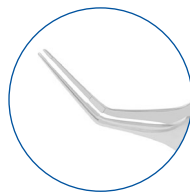

Gaskin Fragment Forceps

11mm Jaws, Angled

S5-1605

Smooth Jaws

Overall Length: 105mm

S5-1606

5mm Tying Platform

Overall Length: 105mm

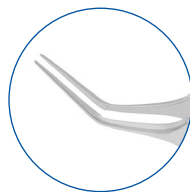

Stephens Capsulotomy Forceps

S5-1607

Overall Length: 119mm
8mm Jaws



Kansas Nucleus Fragment Forceps

S5-1608

Overall Length: 105mm



Nevyas Capsulorhexis Forceps

S5-1609

Overall Length: 106mm
Flat Handle



Harms Tying Forceps

Tying Platform, Smooth Jaws

S5-1610 Straight

Overall Length: 110mm

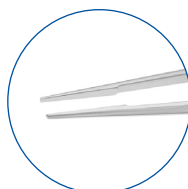

S5-1615 Curved

Overall Length: 114mm

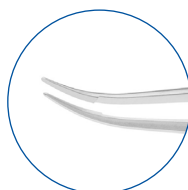

Inamura Capsulorhexis Forceps

S5-1611

Overall Length: 105mm
Cross-Action

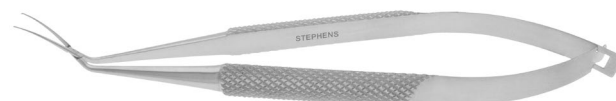
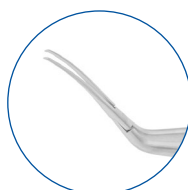

MICS Capsulorhexis Forceps

S5-1613

Overall Length: 104mm
With Guide Marks

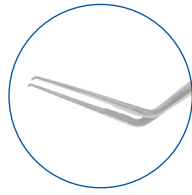

Jaffe Tying Forceps

Tying Platform, Smooth Jaws

S5-1620 Straight

Overall Length: 110mm

S5-1625 Curved

Overall Length: 110mm

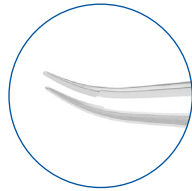
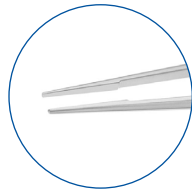

Kelman-McPherson Tying Forceps

8mm Jaws, Angled

S5-1630 Long Handle

Overall Length: 106mm

S5-1632 Short Handle

Overall Length: 81mm

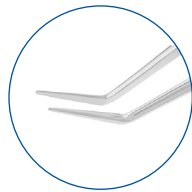

Bonn Tying Forceps

S5-1635

Overall Length: 98mm
Tying Platform, 0.12mm

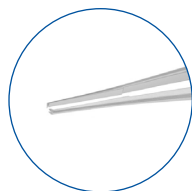

McPherson Tying Forceps

Smooth Jaw

S5-1640 Straight
Overall Length: 86mm

S5-1645 Angled
Overall Length: 85mm

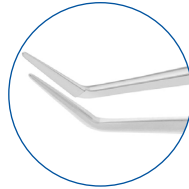
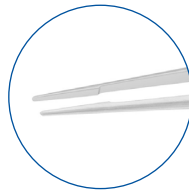

McPherson Tying Forceps

1x2 Teeth

S5-1643 Straight
Overall Length: 84mm

S5-1647 Angled
Overall Length: 79mm

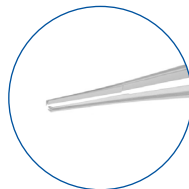

McPherson Tying Forceps

Tying Platform, Long Handle

S5-1650 Straight
Overall Length: 111mm

S5-1655 Angled
Overall Length: 107mm

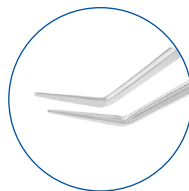
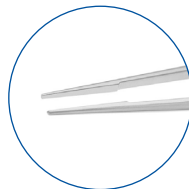

DMEK Tissue Prep Forceps

S5-1655M
Overall Length: 101mm
2.5mm Platform



Shepard Tying Forceps

6mm Jaws

S5-1656 Straight

Overall Length: 111mm

S5-1657 Angled

Overall Length: 100mm

S5-1658 Curved

Overall Length: 110mm



Sinsky Tying Forceps

S5-1660

Overall Length: 106mm

Smooth Jaws

Straight

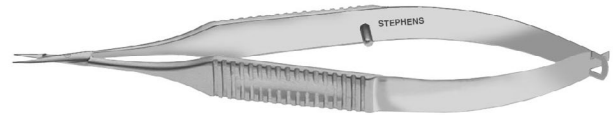

Sauer Suture Forceps

S5-1666

Overall Length: 87mm

1x2 Teeth, Oblique Angle

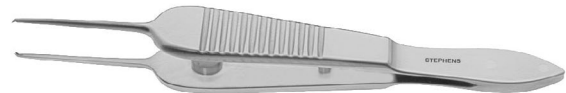
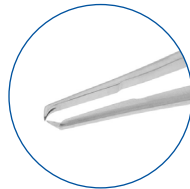

Paufique Suture Forceps

S5-1667

Overall Length: 83mm

1x2 Teeth, Tying Platform

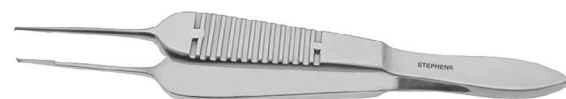
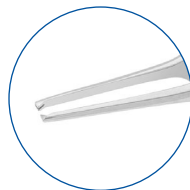

Manhattan Eye & Ear Forceps

S5-1668

Overall Length: 87mm

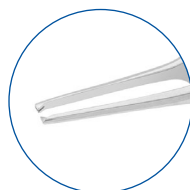

Tennant Tying Forceps

Tying Platform

S5-1670 Straight
Overall Length: 103mm

S5-1675 Curved
Overall Length: 103mm

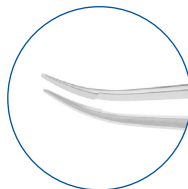
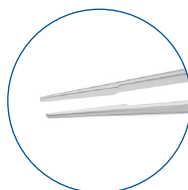

Stephens Tying Forceps

Tying Platform

S5-1676 Straight
Overall Length: 104mm

S5-1677 Curved
Overall Length: 99mm

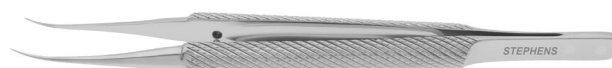
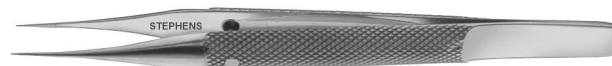

Lieberman-Tennant Tying Forceps

Guide Pin

S5-1678 Straight
Overall Length: 105mm

S5-1679 Curved
Overall Length: 105mm

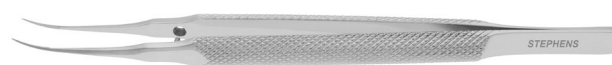
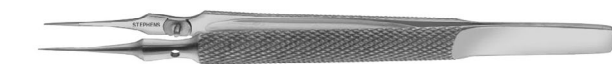

Paton Tying Forceps

S5-1680
Overall Length: 104mm
Tying Platform, Sharp Point

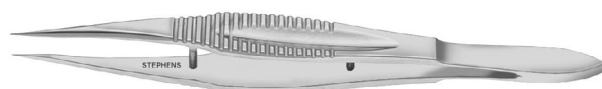

Jewelers Forceps

S5-1690

Overall Length: 120mm
#1, Straight



Jewelers Forceps

S5-1695

Overall Length: 120mm
#3, Straight



Jewelers Forceps

S5-1695T

Overall Length: 118mm
#3 Straight
Tying Platform

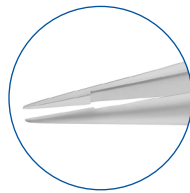

Jewelers Forceps

S5-1700

Overall Length: 111mm
#3C, Straight
Short Taper



Jewelers Forceps

S5-1705

Overall Length: 113mm
#4, Straight



Jewelers Forceps

S5-1710

Overall Length: 113mm
#5, Straight



Jewelers Forceps

S5-1715

Overall Length: 113mm
#5A, Angled



Jewelers Forceps

S5-1720

Overall Length: 115mm
#7, Curved



Binkhorst Lens Forceps

S5-1735

Overall Length: 115mm



Blaydes Lens Forceps

S5-1741

Overall Length: 111mm



Kelman Lens Holding & Manipulating Forceps

S5-1742

Overall Length: 118mm



Stephens Lens Folding Forceps

S5-1793

Overall Length: 105mm



Livernois Lens Forceps

S5-1794M

Overall Length: 108mm



Cross-Action Lens Folding Forceps

S5-1798

Overall Length: 106mm

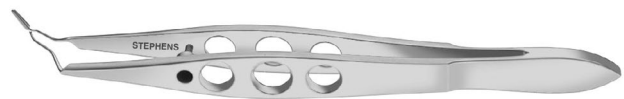

Stephens Lens Insertion Forceps

S5-1799

Overall Length: 115mm



Shepard Lens Holding Forceps

S5-1800

Overall Length: 118mm



Stephens Soft IOL Insertion Forceps

S5-1802

Overall Length: 107mm



Humer Lens Folding Forceps

S5-1804

Overall Length: 110mm



Shepard Lens Forceps

S5-1805 with Lock

Overall Length: 118mm

S5-1820 with Notches on jaw

Overall Length: 112mm



Artisan Lens Implantation Forceps

S5-1815

Overall Length: 121mm



Dimarco Lens Folding-Insertion Forceps

S5-1836

Overall Length: 135mm



Sattler Muscle Forceps

with Lock

S5-1840 Left

Overall Length: 98mm

S5-1845 Right

Overall Length: 98mm



Jameson Muscle Forceps

with Lock

S5-1850 Child, Right

Overall Length: 98mm

S5-1855 Child, Left

Overall Length: 98mm

S5-1860 Adult, Left

Overall Length: 99mm

S5-1865 Adult, Right

Overall Length: 99mm



Swiss Model Muscle Forceps

S5-1870 Left

Overall Length: 112mm

S5-1875 Right

Overall Length: 112mm



Gunderson Muscle Forceps

S5-1880

Overall Length: 114mm



Putterman Muscle Conjunctival Clamp

S5-1885

Overall Length: 94mm



Foreign Body Forceps

S5-1890

Overall Length: 86mm



Bonaccolto Utility & Splinter Forceps

S5-1895

Overall Length: 110mm

Serrated

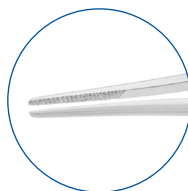

Bores Incision Spreading Forceps

S5-1900

Overall Length: 107mm

Serrated Jaws

0.5mm



Dodick Nucleus Cracker

S5-1901

Overall Length: 109mm

Long Handle



Dodick Nucleus Pre-Splitter

S5-1901B

Overall Length: 108mm



Dodick Nucleus Cracker

S5-1902

Overall Length: 75mm

Short Gills Handle



Stephens Phaco Pre-Splitter

S5-1903

Overall Length: 120mm

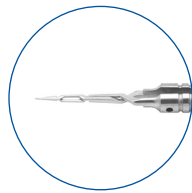

Akahoshi Pre-Chop

S5-1903A

Overall Length: 120mm

Angled Jaws

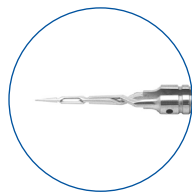

Akahoshi Pre-Chop

S5-1903C

Overall Length: 120mm

Combo Jaws

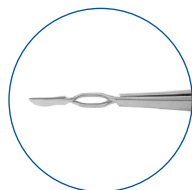

Akahoshi Pre-Chop

S5-1903P

Overall Length: 120mm
Paddle Jaws

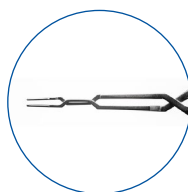

Baby Jones Towel Clamp

S5-1904

Overall Length: 56mm



Backhaus Towel Clamp

S5-1904A

Overall Length: 108mm



Mosquito Hemostat



S5-1905 Short Model, Straight

Overall Length: 90mm



S5-1910 Short Model, Curved

Overall Length: 90mm



S5-1915 Long Model, Straight

Overall Length: 145mm

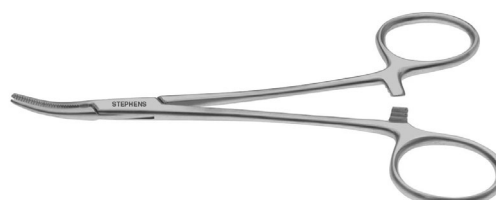

S5-1920 Long Model, Curved

Overall Length: 126mm

Diffenbach Serrefine

S5-1925 Straight

Overall Length: 37mm

S5-1930 Curved

Overall Length: 38mm



Utility Forceps

S5-1935

Overall Length: 100mm

Serrated, Straight

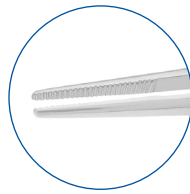

Utility Forceps

S5-1940

Overall Length: 102mm

1x2 Teeth, Straight

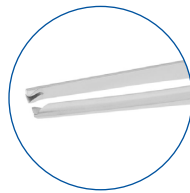

Mccullough Utility Forceps

S5-1945

Overall Length: 93mm

Serrated

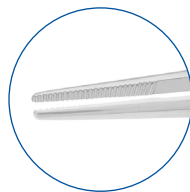

Mccullough Utility Forceps

S5-1950

Overall Length: 94.5mm

1x2 Teeth



Wills Hospital Utility Forceps

S5-1955

Overall Length: 101mm
Serrated

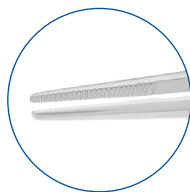

Bonaccolto Utility Forceps

S5-1960 Delicate Model

Overall Length: 106mm

S5-1965 Heavy Model

Overall Length: 105mm

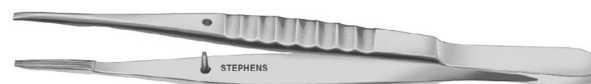

Beyer Rongeur Forceps

S5-1980

Overall Length: 140mm



Citelli Rongeur Forceps

S5-1985

Overall Length: 146mm



Kerrison Rongeur Forceps



S5-1990 #1

Overall Length: 170mm
3.5mm Punch



S5-1995 #2

Overall Length: 165mm
4.0mm Punch



S5-2000 #3

Overall Length: 185mm
4.5mm Punch

Pierce Tissue Fixation Forceps

S5-2005

Overall Length: 95mm



Pierce Corneal Forceps

S5-2020

Overall Length: 84mm

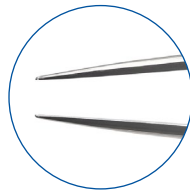

Pierce Forceps

S5-2025

Overall Length: 88mm
Fine Jaws for Microscopic Use

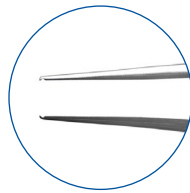

Pierce Tissue Fixation Forceps

S5-2030

Overall Length: 81mm



Pierce Tying Forceps

S5-2055

Overall Length: 86mm
Elongated Tip

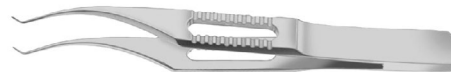
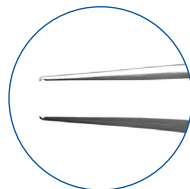

Barraquer Needle Holder

Standard Jaws, Curved

S6-1000 without Lock

Overall Length: 136mm

S6-1005 with Lock

Overall Length: 136mm

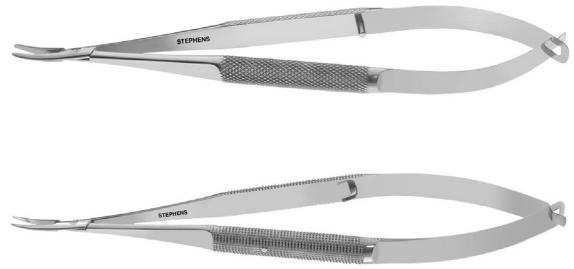

Barraquer Needle Holder

Heavy Jaws

S6-1006 Straight, with Lock

Overall Length: 135mm

S6-1007 Straight, without Lock

Overall Length: 137mm

S6-1008 Curved, with Lock

Overall Length: 130mm

S6-1009 Curved, without Lock

Overall Length: 135mm

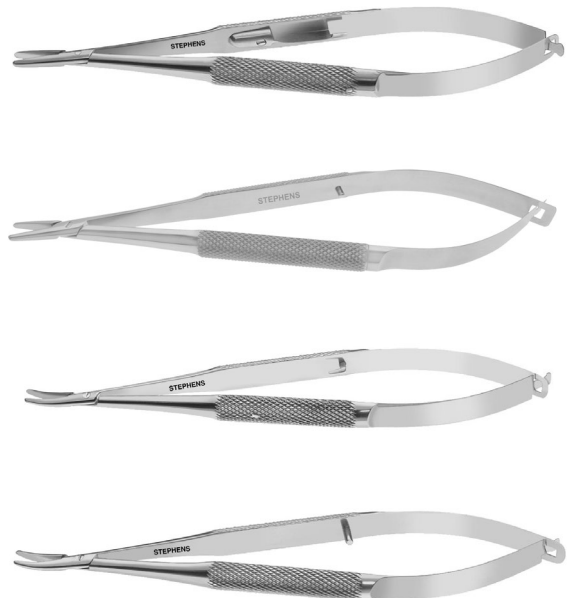

Barraquer Needle Holder

0.5mm Jaws, Curved

S6-1010 without Lock

Overall Length: 145mm

S6-1015 with Lock

Overall Length: 141mm



Barraquer Needle Holder

0.75mm Jaws, Curved

S6-1020 without Lock

Overall Length: 143mm

S6-1025 with Lock

Overall Length: 146mm



Barraquer Short Needle Holder

Delicate Jaws

S6-1030 Straight, without Lock

Overall Length: 94mm

S6-1035 Straight, with Lock

Overall Length: 96mm

S6-1040 Curved, without Lock

Overall Length: 93mm

S6-1045 Curved, with Lock

Overall Length: 95mm

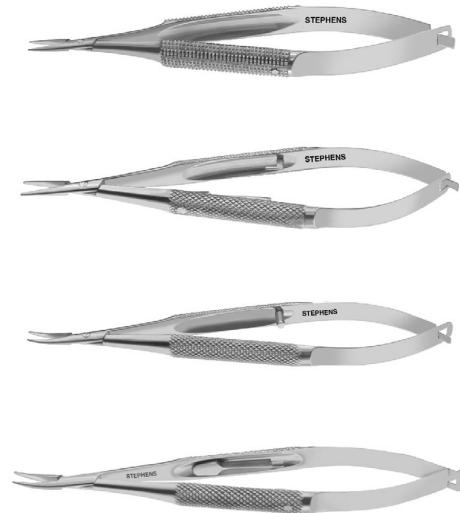

Castroviejo Needle Holder

Standard Jaws

S6-1050 Straight, with Lock

Overall Length: 142mm

S6-1051 Straight, without Lock

Overall Length: 138mm

S6-1052 Curved, without Lock

Overall Length: 138mm

S6-1055 Curved, with Lock

Overall Length: 144mm

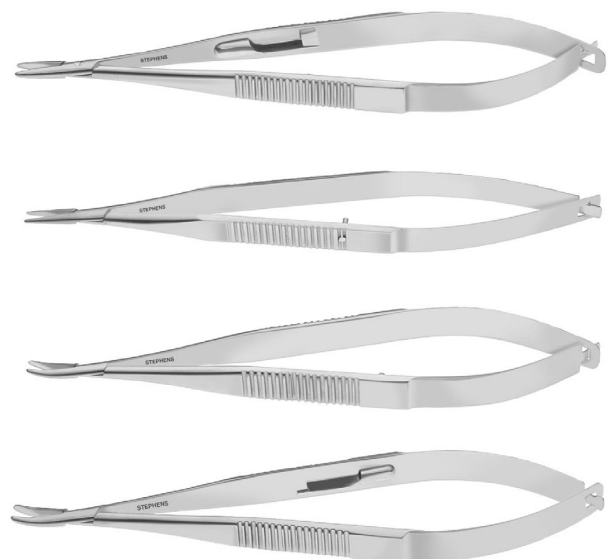

Castroviejo Needle Holder

Delicate Jaws

S6-1060 Straight, without Lock

Overall Length: 136mm

S6-1065 Straight, with Lock

Overall Length: 142mm

S6-1070 Curved, without Lock

Overall Length: 137mm

S6-1075 Curved, with Lock

Overall Length: 140mm

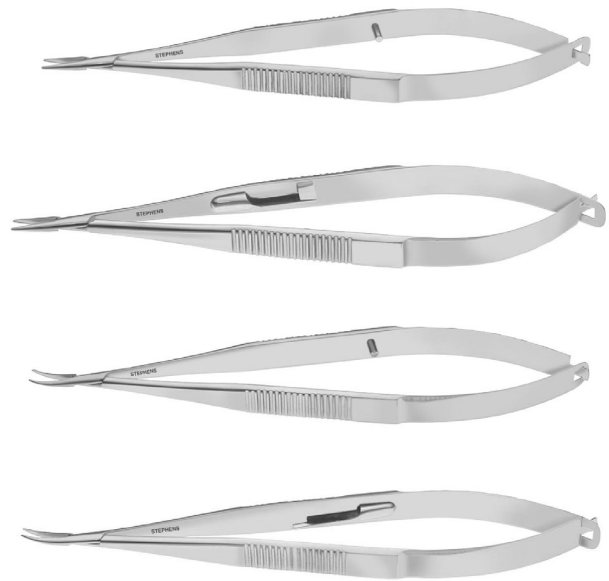

Castroviejo Needle Holder

Delicate Conical Jaws

S6-1076 Straight, without Lock

Overall Length: 131mm

S6-1077 Straight, with Lock

Overall Length: 132mm

S6-1078 Curved, without Lock

Overall Length: 129mm

S6-1079 Curved, with Lock

Overall Length: 136mm

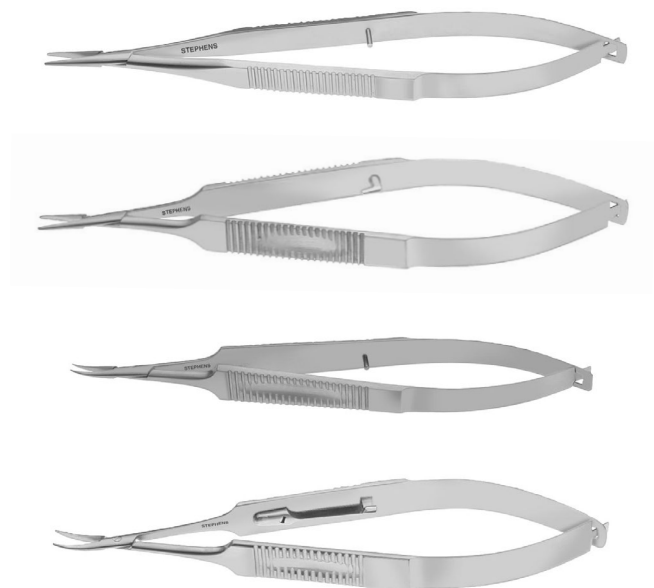

Castroviejo Needle Holder

Round Handle, Standard Conical Jaws

S6-1080 Straight, without Lock

Overall Length: 125mm

S6-1085 Straight, with Lock

Overall Length: 126mm



Jaffe Needle Holder

Delicate Conical Jaws

S6-1090 Straight, without Lock

Overall Length: 138mm

S6-1095 Straight, with Lock

Overall Length: 133mm



Jaffe Needle Holder

Delicate Jaws

S6-1100 Curved, without Lock

Overall Length: 134mm

S6-1105 Curved, with Lock

Overall Length: 136mm



Kalt Needle Holder

S6-1110 Straight

Overall Length: 138mm

S6-1111 Curved

Overall Length: 137mm



Stephens Needle Holder

Delicate Jaws

S6-1115 Straight, without Lock

Overall Length: 127mm

S6-1120 Straight, with Lock

Overall Length: 125mm

S6-1125 Curved, without Lock

Overall Length: 123mm

S6-1130 Curved, with Lock

Overall Length: 120mm

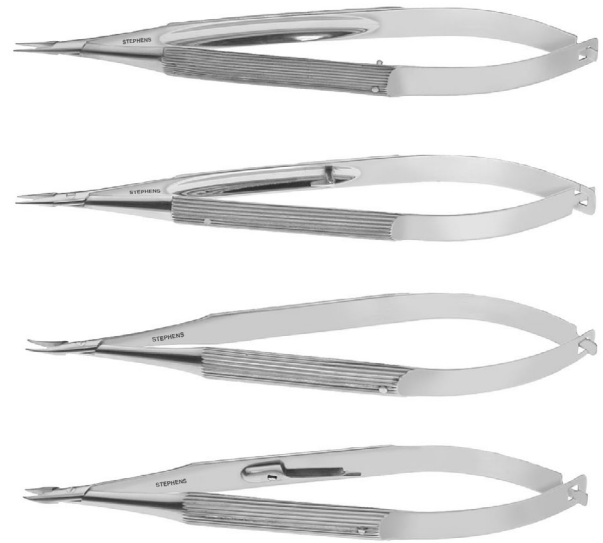

McPherson Needle Holder

Delicate Jaws

S6-1140 Straight, without Lock

Overall Length: 108mm

S6-1145 Straight, with Lock

Overall Length: 111mm

S6-1150 Curved, without Lock

Overall Length: 112mm

S6-1155 Curved, with Lock

Overall Length: 111mm



Micro Needle Holder

S6-1160 Straight, without Lock

Overall Length: 109mm

S6-1165 Straight, with Lock

Overall Length: 113mm

S6-1170 Curved, without Lock

Overall Length: 105mm

S6-1175 Curved, with Lock

Overall Length: 100mm

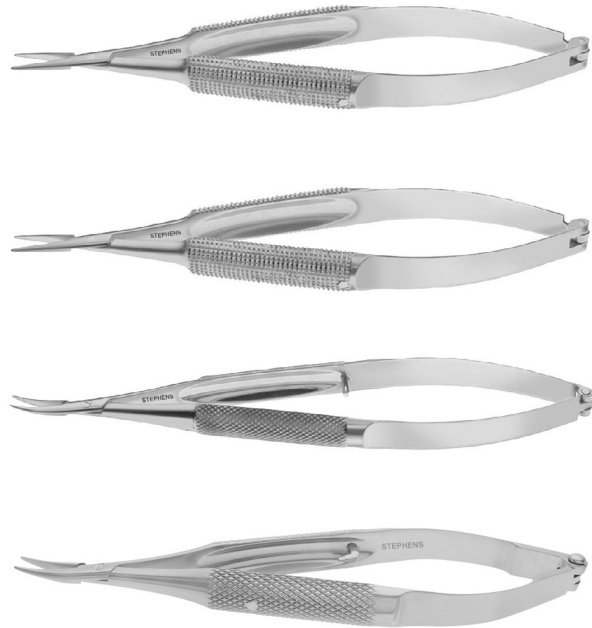

Barraquer-Troutman Needle Holder

Curved

S6-1185 without Lock

Overall Length: 96mm

S6-1190 with Lock

Overall Length: 99mm



Castroviejo Micro Surgery Needle Holder

Straight

S6-1195 without Lock

Overall Length: 88mm

S6-1200 with Lock

Overall Length: 97mm



Barraquer-Troutman Needle Holder

Micro Jaws, 0.5mm, Curved

S6-1205 without Lock

Overall Length: 134mm

S6-1210 with Lock

Overall Length: 126mm



Troutman Needle Holder

Delicate Jaws, Strong Curve

S6-1215 without Lock

Overall Length: 122mm

S6-1220 with Lock

Overall Length: 120mm



Shaws Needle Holder

S6-1250 Straight

Overall Length: 96mm

S6-1255 Curved

Overall Length: 90mm



Iris Scissors

Short Model

S7-1000 Straight

Overall Length: 92mm

S7-1005 Curved

Overall Length: 90mm



Iris Scissors

S7-1010

Overall Length: 97mm
Angled



Iris Scissors

Long Model

S7-1015 Straight

Overall Length: 110mm

S7-1020 Curved

Overall Length: 109mm



Iris Scissors

S7-1030

Overall Length: 107mm
Ribbon Type
Curved



Large Ring Scissors

S7-1035 Straight

Overall Length: 109mm

S7-1040 Curved

Overall Length: 112mm



Needle Point Stitch Scissors

S7-1045 Straight

Overall Length: 100mm

S7-1050 Curved

Overall Length: 105mm



Knapp Strabismus Scissors

S7-1055 Straight

Overall Length: 107mm

S7-1060 Curved

Overall Length: 106mm



Strabismus Scissors

S7-1065

Overall Length: 108mm

Straight, with Probe Points



Maunoir Iris Scissors

S7-1070

Overall Length: 107mm



Aebli Angular Scissors

S7-1075 Right

Overall Length: 101mm

S7-1080 Left

Overall Length: 96mm



Stevens Tenotomy Scissors

S7-1085 Straight

Overall Length: 115mm

S7-1090 Curved

Overall Length: 115mm

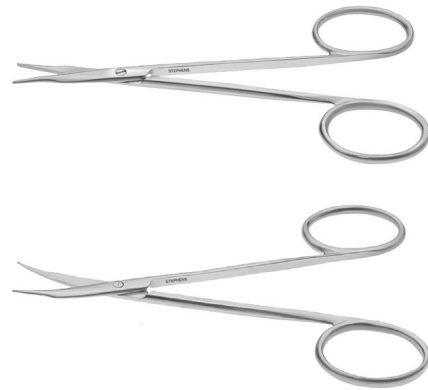

Stevens Tenotomy Scissors

Ribbon Type

S7-1095 Straight

Overall Length: 101mm

S7-1100 Curved

Overall Length: 100mm



Knapp Strabismus Scissors

S7-1110 Straight

Overall Length: 120mm

S7-1115 Curved

Overall Length: 121mm

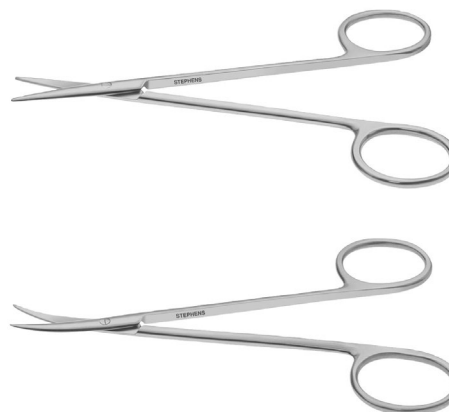

Knapp Strabismus Scissors

S7-1117

Overall Length: 119mm

Strong Curve



Knapp Strabismus Scissors

Ribbon Type

S7-1120 Straight

Overall Length: 108mm

S7-1125 Curved

Overall Length: 111mm

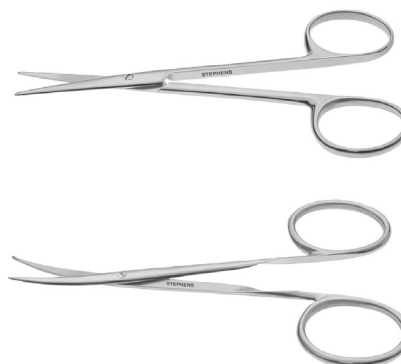

Enucleation Scissors

S7-1130

Overall Length: 136mm

Medium Curve



Enucleation Scissors

S7-1135 Strong Curve

Overall Length: 132mm

S7-1137 Light Curve

Overall Length: 134mm



Stephens DALK Scissors

S7-1150

Overall Length: 102mm

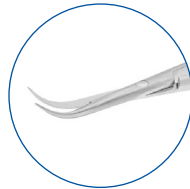

Castroviejo Corneal Section Scissors

Small

S7-1165 Right

Overall Length: 108mm

S7-1170 Left

Overall Length: 107mm



Castroviejo Corneal Section Scissors

Medium

S7-1175 Right

Overall Length: 109mm

S7-1180 Left

Overall Length: 110mm

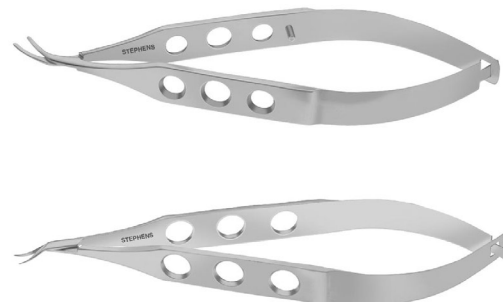

Troutman-Castroviejo Scissors

Small Blades

S7-1185 Right

Overall Length: 108mm

S7-1190 Left

Overall Length: 110mm



Troutman-Castroviejo Corneal Scissors

S7-1191 Right

Overall Length: 110mm

S7-1192 Left

Overall Length: 107mm

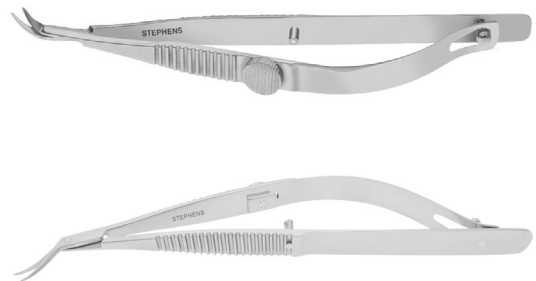

Troutman-Castroviejo Corneal Scissors

Medium Blades

S7-1195 Right

Overall Length: 108mm

S7-1200 Left

Overall Length: 109mm



Miniature Corneal Scissors

S7-1205

Overall Length: 98mm

Blunt

Angled



Miniature Corneal Scissors

S7-1210

Overall Length: 96mm
Blunt, Curved



Mcguire Corneal Scissors

S7-1211 Right

Overall Length: 108mm

S7-1212 Left

Overall Length: 112mm



Castroviejo Corneal Scissors

S7-1233

Overall Length: 112mm
Large Blades
Curved, Blunt
Wide Handle



Castroviejo Corneal Scissors

Large Blades, Curved, Blunt Tip

S7-1234 Wide Handle

Overall Length: 132mm

S7-1235 Standard Handle

Overall Length: 115mm



Azar Corneal Scissors

S7-1235A

Overall Length: 112mm
Marked for Incision Measurement
1mm - 6mm



Castroviejo Corneal Scissors

S7-1240

Overall Length: 117mm
Medium Blades
Curved, Blunt

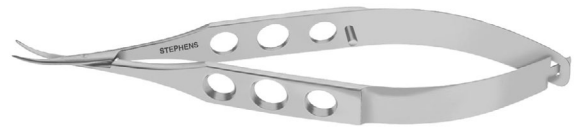

Castroviejo Corneal Section Scissors

S7-1245

Overall Length: 106mm
Small Blades
Curved, Blunt



Castroviejo Universal Scissors

S7-1246

Overall Length: 93mm
Small Blades



Castroviejo Corneal Scissors

S7-1250

Overall Length: 116mm
Strong Curve



Shepard-Castro Corneal Scissors

S7-1255

Overall Length: 115mm

One Serrated Blade

Curved, Blunt



Katzin Miniature Scissors

S7-1260 Right

Overall Length: 102mm

S7-1265 Left

Overall Length: 100mm



Troutman Miniature Corneal Section Scissors

S7-1270 Right

Overall Length: 95mm

S7-1275 Left

Overall Length: 93mm



Lund Micro Keratoplasty Scissors

S7-1280 Right

Overall Length: 100mm

S7-1285 Left

Overall Length: 98mm



Castroviejo Keratoplasty Scissors

Blunt, Angled

S7-1290 Small Blades

Overall Length: 113mm

S7-1295 Medium Blades

Overall Length: 109mm



McPherson-Westcott Conjunctiva Scissors

S7-1305

Overall Length: 106mm

Small Blades

Curved, Blunt

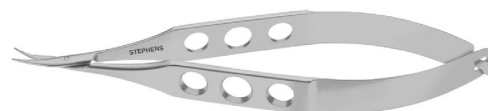

Westcott-Barraquer Scissors

S7-1310 Sharp

Overall Length: 112mm

S7-1311 Blunt

Overall Length: 109mm



Westcott Tenotomy Scissors

S7-1314

Overall Length: 111mm

Straight



Westcott Tenotomy Stitch Scissors

S7-1315

Overall Length: 105mm

Straight

Extra Sharp



Westcott Tenotomy Scissors

Standard Blades

S7-1320 Sharp

Overall Length: 115mm

S7-1325 Blunt

Overall Length: 115mm



Westcott Tenotomy Scissors

S7-1321

Overall Length: 97mm

Short Model



Stephens-Westcott Conjunctiva Scissors

S7-1326

Overall Length: 129mm

Curved



McPherson-Westcott Stitch Scissors

S7-1330

Overall Length: 105mm

Small Blades

Extra Sharp



Jaffe Stitch Scissors

S7-1335

Overall Length: 135mm

Long Model

Delicate, Sharp Tip



Jaffe Stitch Scissors

S7-1336

Overall Length: 114mm

Short Model

Delicate, Sharp Tip

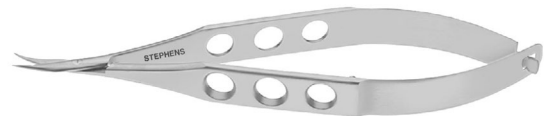

Iris Miniature Scissors

S7-1340

Overall Length: 100mm

Sharp Tips

Straight



Iris Miniature Scissors

S7-1345

Overall Length: 94mm

Sharp, Curved



Barraquer Iris Scissors

S7-1360

Overall Length: 57mm

7mm Blades



Stephens Scissors

S7-1364

Overall Length: 112mm



Barraquer Iris Scissors

S7-1365

Overall Length: 59mm
10mm Blades



Stephens-Vannas Scissors

7mm Blades

S7-1366 Straight

Overall Length: 105mm

S7-1367 Curved

Overall Length: 105mm

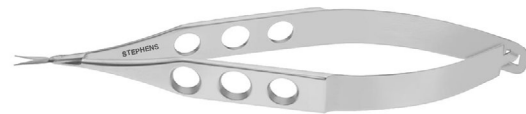

Stephens-Gills Scissors

11mm Blades

S7-1368 Straight

Overall Length: 109mm

S7-1369 Curved

Overall Length: 107mm



Vannas Capsulotomy Scissors

S7-1370 Straight

Overall Length: 82mm

S7-1375 Curved

Overall Length: 84mm



Vannas Capsulotomy Scissors

S7-1380

Overall Length: 80mm
Angled



Stern-Gills Vannas Scissors

S7-1384

Overall Length: 111mm
11mm Blades



Vannas Capsulotomy Scissors

S7-1385

Overall Length: 82mm
Angled Forward



Gills Vannas Scissors

11mm Blade, Delicate

S7-1386 Angled

Overall Length: 89mm

S7-1387 Straight

Overall Length: 87mm

S7-1388 Curved

Overall Length: 86mm



Cohan-Vannas Scissors

S7-1389

Overall Length: 62mm
Delicate Blades
Sharp



Corneal Scissors

S7-1460

Overall Length: 106mm
Round Handle
Straight



Harms Trabeculotomy Probe

S8-1000 Right

Overall Length: 47mm

S8-1005 Left

Overall Length: 47mm



Lacrimal Dilator

S8-1010

Overall Length: 75mm
Infant



Castroviejo Lacrimal Dilator

S8-1015

Overall Length: 137mm
Medium & Fine Tips



Muldon Lacrimal Dilator

S8-1020

Overall Length: 110mm
Graduated Tip



Simpson Lacrimal Dilator

S8-1025 #1, Medium

Overall Length: 106mm

S8-1030 #2, Fine

Overall Length: 110mm



Wilder Lacrimal Dilator

S8-1035 Heavy Taper

Overall Length: 100mm

S8-1040 Medium Taper

Overall Length: 101mm

S8-1045 Fine Taper

Overall Length: 101mm

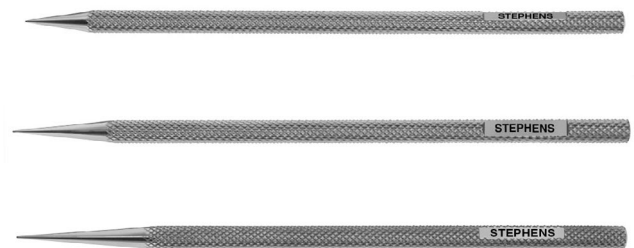

Naugle-Fleming Knurled Dilator

S8-1035M

Overall Length: 100mm

3.5mm Diameter, CDCR



Ziegler Lacrimal Canal Probe

S8-1050

Overall Length: 122mm



Rolf Lacrimal Sac Probe

S8-1055

Overall Length: 148mm



Pigtail Probe With Suture Holes

S8-1060

Overall Length: 155mm



Bowman Lacrimal Probe

Sterling Silver

S8-1065 4/0 - 3/0

Overall Length: 153mm

S8-1070 00 - 0

Overall Length: 153mm

S8-1075 1 - 2

Overall Length: 153mm

S8-1080 3 - 4

Overall Length: 152mm

S8-1085 5 - 6

Overall Length: 153mm

S8-1090 7 - 8

Overall Length: 155mm

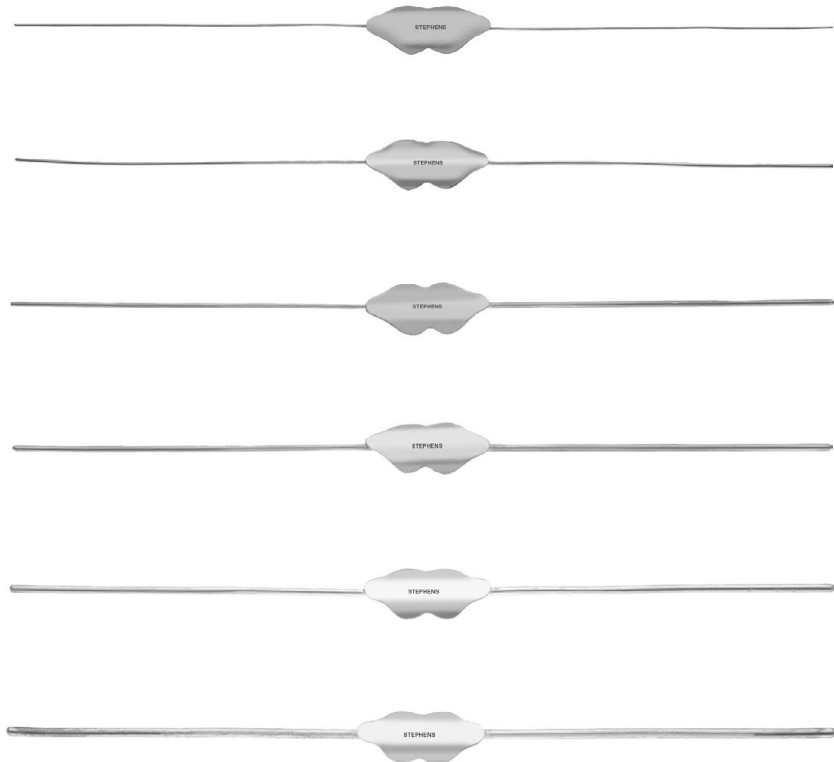

Williams Lacrimal Bulbous Probe

Sterling Silver

S8-1095 00 - 0

Overall Length: 153mm

S8-1100 1 - 2

Overall Length: 153mm

S8-1105 3 - 4

Overall Length: 153mm

S8-1110 5 - 6

Overall Length: 153mm

S8-1115 7 - 8

Overall Length: 146mm

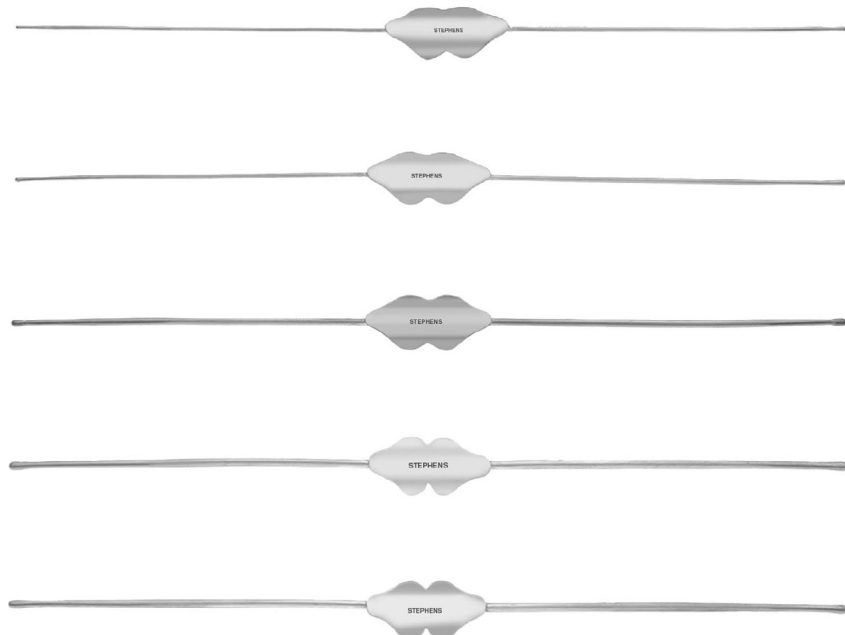

VeraPlug Punctal Sizer

S8-1200 (Small/Medium) 0.5 - 0.6

Overall Length: 91mm

S8-1205 (Large/Extra Large) 0.7 - 0.8

Overall Length: 91mm

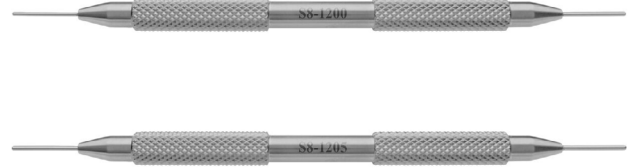

Punctal Gauge Set with Sterilization Tray

S8-1210

0.5–0.6, 0.7–0.8

Tray Size: 2.5" x 6" x 0.75"

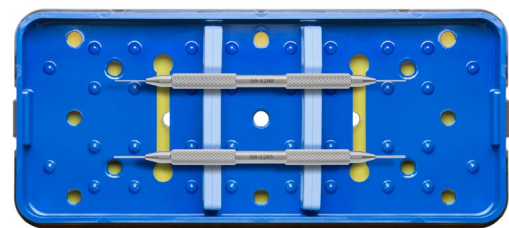

Shepard-Hoffer Optic Zone Marker with Cross Hairs

S9-1000 3.0mm

Overall Length: 102mm

S9-1001 2.75mm

Overall Length: 83mm

S9-1005 3.25mm

Overall Length: 110mm

S9-1010 3.50mm

Overall Length: 100mm

S9-1015 3.75mm

Overall Length: 80mm

S9-1020 4.0mm

Overall Length: 109mm

S9-1025 4.25mm

Overall Length: 84mm

S9-1030 4.5mm

Overall Length: 83mm

S9-1035 4.75mm

Overall Length: 101mm

S9-1040 5.0mm

Overall Length: 106mm

S9-1041 5.5mm

Overall Length: 99mm

S9-1045 6.0mm

Overall Length: 106mm

S9-1050 6.5mm

Overall Length: 86mm

S9-1055 7.0mm

Overall Length: 113mm

S9-1060 7.5mm

Overall Length: 113mm

S9-1064 8.0mm

Overall Length: 129mm

S9-1065 9.0mm

Overall Length: 116mm



Mendez Axis Finder

S9-1068

Overall Length: 112mm



4 Line Astigmatism Marker

S9-1108

Overall Length: 112mm



Radial Marker

90 Degree

S9-1109 4 Incisions

Overall Length: 111mm

S9-1110 6 Incisions

Overall Length: 108mm

S9-1115 8 Incisions

Overall Length: 107mm

S9-1116 10 Incisions

Overall Length: 110mm

S9-1120 12 Incisions

Overall Length: 109mm

S9-1125 16 Incisions

Overall Length: 112mm



Bores Radial Marker

S9-1127 6 Blade

Overall Length: 105mm

S9-1128 8 Blade

Overall Length: 104mm



Thornton Low Profile Marker

Gunpoint

- S9-1251** 3.0mm
Overall Length: 79mm
- S9-1252** 3.25mm
Overall Length: 83mm
- S9-1253** 3.5mm
Overall Length: 81mm
- S9-1254** 3.75mm
Overall Length: 99mm
- S9-1255** 4.0mm
Overall Length: 84mm
- S9-1260** 4.25mm
Overall Length: 84mm
- S9-1261** 4.5mm
Overall Length: 85mm

- S9-1262** 4.75mm
Overall Length: 84mm
- S9-1263** 5.0mm
Overall Length: 85mm
- S9-1263A** 5.5mm
Overall Length: 90mm
- S9-1264** 6.0mm
Overall Length: 85mm
- S9-1265** 7.0mm
Overall Length: 84mm
- S9-1266** 8.0mm
Overall Length: 99mm



Grandon T-Incision Marker

- S9-1400** 2.0mm
Overall Length: 113mm
- S9-1403** 4.0mm
Overall Length: 114mm



Pettigrove PRK Marker/Spatula

- S9-1407** 6.0mm
Overall Length: 106mm
- S9-1408** 6.5mm
Overall Length: 103mm
- S9-1409** 7.0mm
Overall Length: 100mm



LASEK Alcohol Well

S9-1535 8.5mm

Overall Length: 132mm

S9-1536 9.5mm

Overall Length: 132mm



Bores Axis Marker

S9-1570

Overall Length: 102mm



Berkeley Double Marker

S9-1602 3.5mm & 3.75mm

Overall Length: 126mm

S9-1603 4.0mm & 4.25mm

Overall Length: 124mm

S9-1604 4.5mm & 5.0mm

Overall Length: 126mm



Henderson Pre-Operative Alignment Marker

S9-2033

Overall Length: 103mm



LRI Gravity Marker

S9-2040

Overall Length: 154mm

12.5mm Spread

Marker at 3 and 9



Henderson LRI Axis Marker

S9-2050

Overall Length: 101mm
30, 45, 60 Degree



Henderson Degree Gauge

S9-2060

Overall Length: 107mm



Henderson Toric IOL Marker

S9-2065

Overall Length: 100mm



Stephens Toric IOL Bubble Level Marker

S9-2070

Overall Length: 120mm



Bi-Manual Handpiece

23ga

SC-1003 Complete Set

Overall Length: 37mm

SC-1004 Aspiration

Overall Length: 37mm

SC-1004A Irrigation

Overall Length: 37mm



Bishop-Harmon Anterior Chamber Irrigator

- SC-1005** Complete Set, Overall Length: 42mm
- SC-1010** Silicone Bulb, Overall Length: 55mm
- SC-1015** Bulb Adaptor, Overall Length: 25mm
- SC-1020** Irrigation Cannula 19ga, Overall Length: 28mm



Bracken Irrigating Cannula

SC-1025

Overall Length: 43mm
Anterior Chamber
19ga
Curved



Gills Irrigating Cannula

SC-1065

Overall Length: 40mm
25ga Angled, 8mm



Welsh Flat Olive Tip

SC-1066

Overall Length: 43mm
25ga, Straight



Hirschman Irrigating Cannula

Spatulated Tip, 23ga

SC-1075 Right

Overall Length: 33mm

SC-1080 Left

Overall Length: 32mm



Knolle Irrigating Cannula



SC-1095 30ga
Overall Length: 37mm



SC-1100 23ga
Overall Length: 38mm



SC-1101 25ga
Overall Length: 38mm

Knolle-Pearce Vectis Cannula

23ga

SC-1105 3 Irrigation Holes

Overall Length: 38mm

SC-1106 1 Straight & 2 Reverse Holes

Overall Length: 51mm



Heart-Shaped Vectis Irrigation Cannula

SC-1107

Overall Length: 52mm

2 Irrigation Holes

23ga



Kratz Irrigating Cannula

SC-1110

Overall Length: 35mm

Sand-Blasted Tip

23ga



Anterior Chamber Cannula

Straight

SC-1115 23ga

Overall Length: 33mm

SC-1125 26ga

Overall Length: 36mm

SC-1135 30ga

Overall Length: 38mm

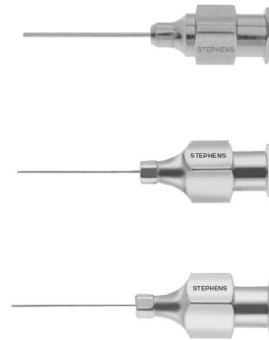

Anterior Chamber Cannula

Angled

SC-1120 23ga

Overall Length: 32mm

SC-1130 26ga

Overall Length: 33mm

SC-1140 30ga

Overall Length: 32mm

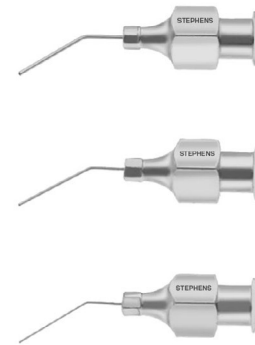

Infusion Hand Piece

SC-1180

Overall Length: 95mm

Autoclavable



Scheie Anterior Chamber Cannula

SC-1185

Overall Length: 36mm

27ga, Blunt



Sheets Irrigating Vectis Cannula

SC-1190

Overall Length: 50mm

3 Holes



West Irrigating Cannula

SC-1220

Overall Length: 44mm

Built Tip, Side Opening

20ga



Wills Eye Irrigating Cannula

SC-1225

Overall Length: 37mm

21ga



Stephens Handle

Irrigating & Aspirating

SC-1230 Standard

Overall Length: 115mm

SC-1235 With Finger Cut-Off Hole

Overall Length: 114mm



Healon Aspirating Cannula

Angled

SC-1315 22ga

Overall Length: 38mm

SC-1316 19ga

Overall Length: 37mm



Jacobi Aspirating & Irrigating Cannula

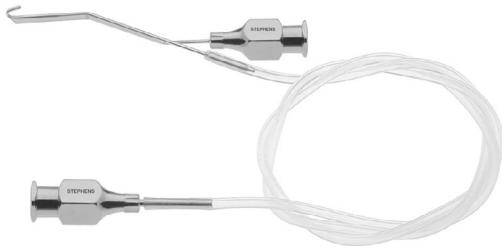

SC-1325 Left

Overall Length: 53mm

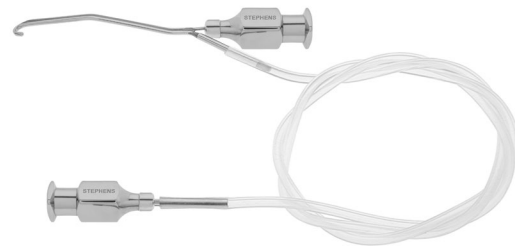

SC-1330 Right

Overall Length: 53mm

Inner Irrigation Cannula

23ga

SC-1365 0.2mm Port

Overall Length: 64mm

SC-1370 0.3mm Port

Overall Length: 66mm

SC-1375 Front Opening

Overall Length: 65mm

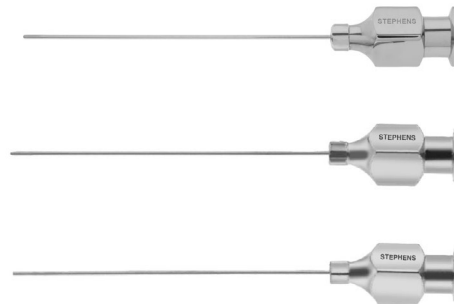

Outer Aspirating Cannula

SC-1380

Overall Length: 32mm

Truncated Tip

19ga



Outer Aspirating Cannula

SC-1385

Overall Length: 36mm

19ga, Straight, Blunt



Bonn Lacrimal Cannula

SC-1430

Overall Length: 42mm



Bailey Infant & Child Lacrimal Cannula

SC-1435

Overall Length: 32mm

23ga, Blunt



Fasanella Lacrimal Cannula

SC-1475

Overall Length: 38mm

Light Curve 22m Tip

23ga



Keislar Lacrimal Cannula

SC-1480

Overall Length: 42mm

23ga, Curved



Lacrimal Cannula

SC-1490

Overall Length: 39mm

Bevelled, Round



Lacrimal Cannula

SC-1500

Overall Length: 36mm
Bevelled, Short Angle



Lacrimal Cannula

SC-1510

Overall Length: 36mm
Beveled, Wide Angle



Lacrimal Cannula

SC-1515

Overall Length: 27mm
23ga, Straight



Lacrimal Cannula

SC-1525

Overall Length: 40mm
19ga, Straight, Closed Front



Lacrimal Cannula

23ga, Reinforced Tip

SC-1530 Straight

Overall Length: 47mm

SC-1535 Curved

Overall Length: 45mm



Lacrimal Cannula

Side Port, 23ga x 0.3mm

SC-1540 Curved

Overall Length: 60mm

SC-1545 Straight

Overall Length: 60mm

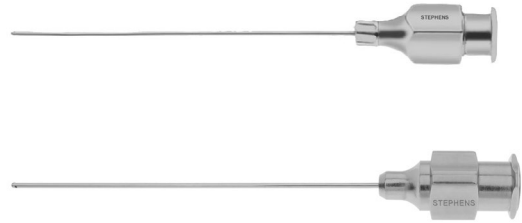

West Lacrimal Cannula

SC-1560

Overall Length: 47mm

Side Port

23ga



Weil Infant Probing Lacrimal Cannula

SC-1565

Overall Length: 50mm

Tip w/ Light Curve & Rounded End

21ga



Troutman Alpha-Chymotrypsin Cannula

SC-1575

Overall Length: 47mm

Bulbous Tip

25ga



Atkinson Retrobulbar Needle

SC-1580

Overall Length: 53mm

23ga, Sharp-Rounded Tip



Retrobulbar Injection Cannula

SC-1585 0.6 x 60mm

Overall Length: 78mm

SC-1590 0.5 x 50mm

Overall Length: 68mm

SC-1595 0.5 x 40mm

Overall Length: 61mm

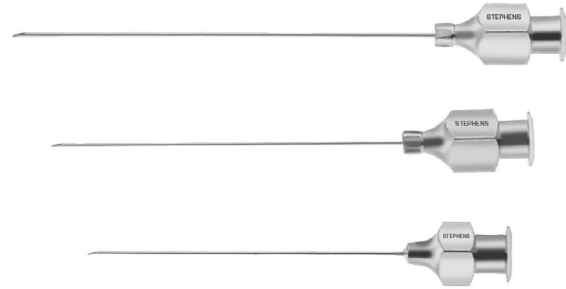

Air Injection Cannula

Smooth Angled Tip

SC-1625 30ga

Overall Length: 39mm

SC-1630 27ga

Overall Length: 36mm



Rainin Air Injection Cannula

Spatulated Tip

SC-1645 30ga

Overall Length: 36mm

SC-1650 27ga

Overall Length: 23mm

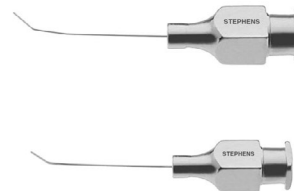

Cystotome Irrigation Cannula

SC-1660

Overall Length: 32mm



Kelman Cystotome Knife Cannula

22ga

SC-1670 Blunt

Overall Length: 46mm

SC-1675 Sharp

Overall Length: 48mm

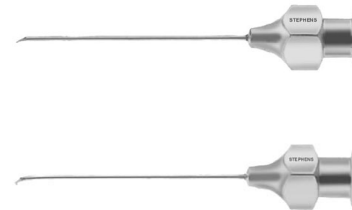

Binkhorst Irrigating Hooked Cannula

SC-1815

Overall Length: 46mm

Straight

22ga



Binkhorst Irrigating Hooked Cannula

22ga

SC-1820 Left

Overall Length: 37mm

SC-1825 Right

Overall Length: 35mm

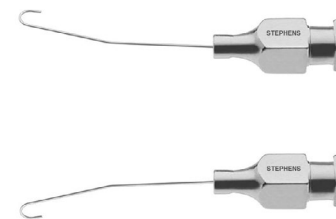

Jensen Posterior Capsule Polisher

SC-1835

Overall Length: 48mm

23ga, Sandblasted Tip



Capsule Polisher

Posterior Capsule Wall Scraper-Polisher

SC-1850 23ga x 2mm

Sand Blasted Tip

Overall Length: 40mm

SC-1855 30ga x 2mm

Sand Blasted Tip

Overall Length: 33mm

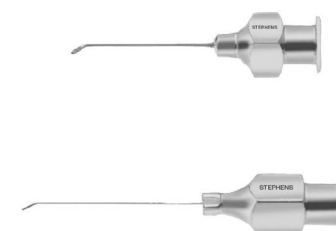

Kratz Capsule Wall Scraper

SC-1865

Overall Length: 39mm
23ga, Angled 1mm



Stephens A/C Maintainer

SC-1887

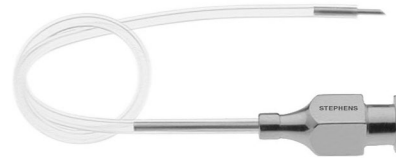

Graether Collar Button Iris Retractor Cannula

Iris Cannula

SC-1901 Straight

Overall Length: 45mm

SC-1903 Vaulted

Overall Length: 45mm



Simcoe Cortex Cannula

SC-1905

Overall Length: 28mm
23ga, Blunt, Side Port



Simcoe Double Barrel I/A Cannula

SC-1906

Overall Length: 35mm
23ga, 0.3mm Port

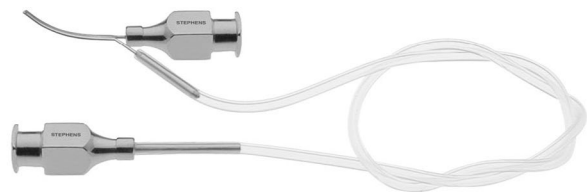

Reverse Simcoe I/A Unit

SC-1907

Overall Length: 35mm
23ga



Kerichoff Aspiration & Irrigation Cannula

SC-1908

Overall Length: 46mm



Simcoe Capsule Scrubber

SC-1910

Overall Length: 32mm
23ga



Shahinian Cannula

SC-2005

Overall Length: 31mm



One Piece Phaco I/A Handpiece

16ga, 0.4mm

SC-3100 Straight

Overall Length: 136mm

SC-3105 Curved

Overall Length: 136mm



Chang Hydrodissection Cannula

SC-5335

Overall Length: 32mm



Pearce Nucleus Hydrodissector

SC-5340

Overall Length: 39mm



Sinsky Nucleus Hydrodissector

SC-5345

Overall Length: 40mm



Sauter Nucleus Hydrodissector

SC-5360

Overall Length: 41mm



Flat End CCH Hydrodissector

SC-5380

Overall Length: 38mm

27ga



Cortical Cleaving Hydrodissection Cannula

SC-5385

Overall Length: 36mm



Pearce J-Shaped Hydrodissector

SC-5390

Overall Length: 41mm



J Shaped Hydrodissector

SC-5395

Overall Length: 41mm



Slade LASIK Cannula

SC-5575

Overall Length: 34mm
26ga



Buratto LASIK Irrigation Cannula

3 Irrigation Holes, Angled

SC-5580 23ga

Overall Length: 46mm

SC-5585 25ga

Overall Length: 43mm



Gimbel Lasik Irrigation Cannula

SC-5590

Overall Length: 33mm
Bullet Shaped
27ga



Gimbel Lasik Polishing Cannula

SC-5595

Overall Length: 31mm
27ga



Gulani Lasik Cannula

SC-5596

Overall Length: 50mm
Irrigation, Polishing, & Debris Removal



Lasik Aspirating Spoon Cannula

SC-5597

Overall Length: 60mm
Debris Removal under Flap



Hersch Lasik Flap Positioner Cannula

SC-5600

Overall Length: 41mm
Flattened Tip
45deg Angle
25ga



Nichamin Lasik Flap Positioner Cannula

Flattened Tip, Front Opening
9mm Tip for Elevation

SC-5602 23ga

Overall Length: 49mm

SC-5603 25ga

Overall Length: 50mm

SC-5604 27ga

Overall Length: 40mm

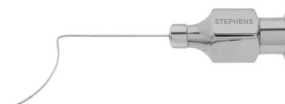

Vidaurri LASIK Flap Irrigator

SC-5605

Overall Length: 43mm



DALK Cannula

SC-5700

Overall Length: 39mm
27ga



Blade Handle

AD-1000 Handle No. 3

For blade #10, 11, 12, and 15
Overall Length: 128mm



AD-1005 Handle No. 7

Overall Length: 128mm



AD-1010 Handle No. 4

Overall Length: 128mm



Beaver Blade Handle

AD-1036

Overall Length: 110mm



Plastic Sterilization Tray

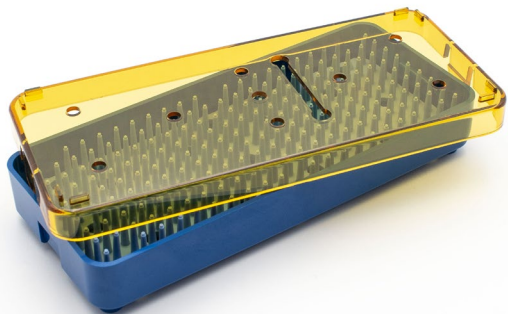

T1-0001

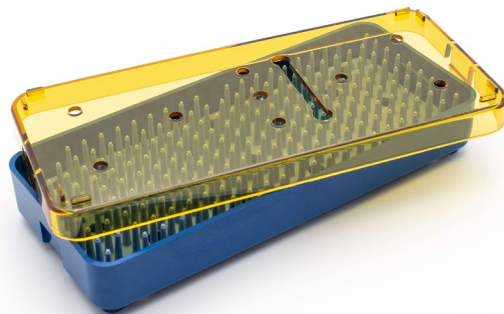

T1-0002

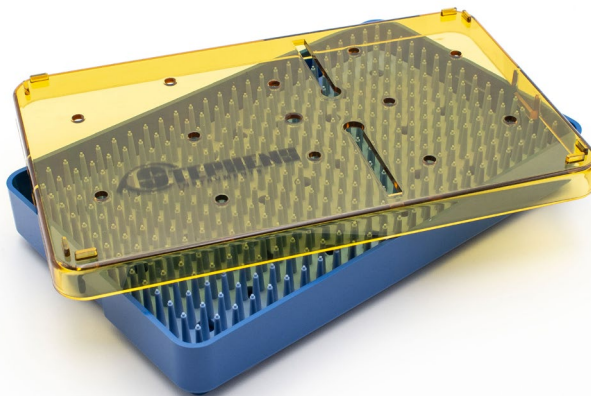

T1-0003

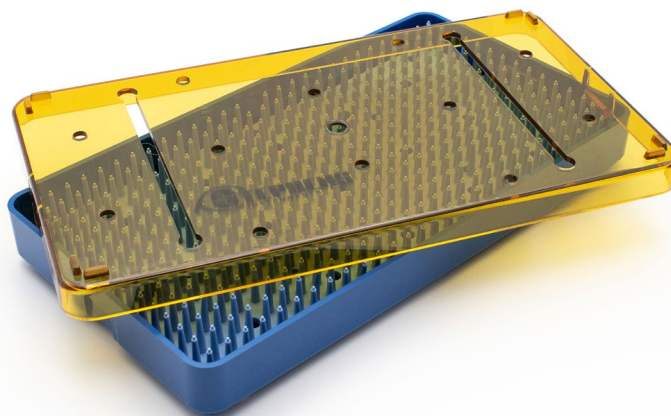

T1-0004

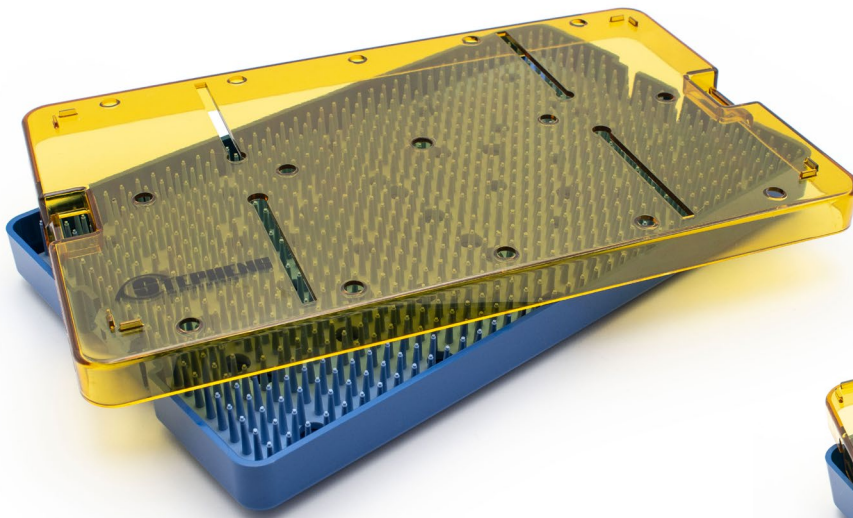

T1-0005

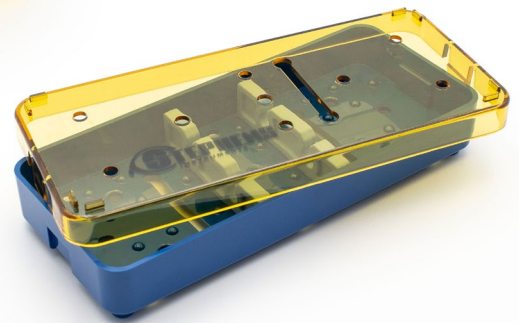

T1-0007

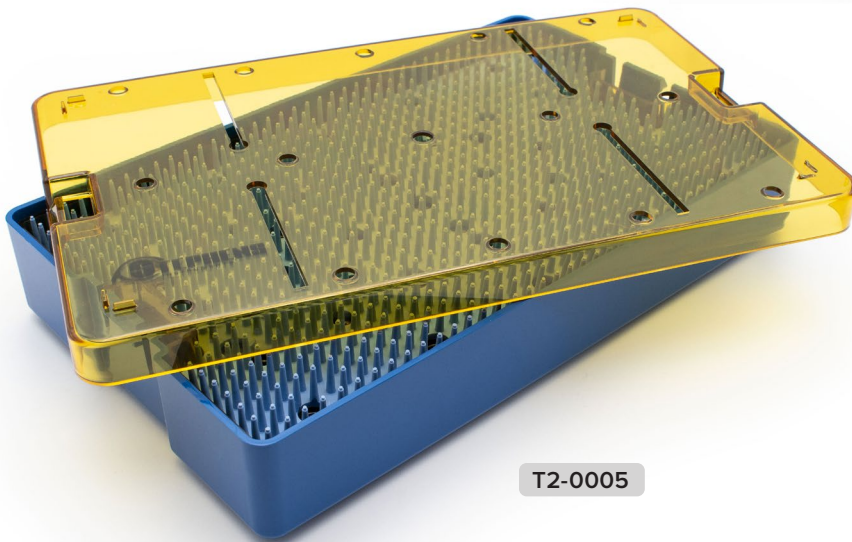

T2-0005

PLASTIC STERILIZATION TRAYS

T1-0001	2.5" x 6" x 0.75"		Silicone Inlay
T1-0002	2.5" x 7.5" x 0.75"		Silicone Inlay
T1-0003	4" x 6.5" x 0.75"		Silicone Inlay
T1-0004	4" x 7.5" x 0.75"		Silicone Inlay
T1-0005	6" x 10" x 0.75"		Silicone Inlay
T1-0007	2.5" x 6" x 0.75"		Silicone Bars
T2-0005	6" x 10" x 1.5"	Double Level	Silicone Inlay



Speculums	134
Manipulator, Hook, Caliper	134
Forceps	136
Needle Holder	140

Titanium Instruments



Lieberman Speculum K-Wire

ST1-1026

Overall Length: 78mm

Titanium



Thornton Fixation Ring

ST1-1211A

Overall Length: 105mm

Titanium



Iris Spatula

ST4-1040

Overall Length: 120mm

Titanium

Smooth, Round



Bechert Nucleus Rotator

ST4-1070

Overall Length: 120mm

Titanium

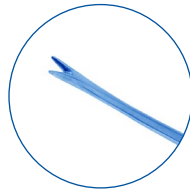

Castroviejo Cyclodialysis Spatula

ST4-1140

Overall Length: 127mm

Titanium

0.75mm



New Orleans Lens Loop

ST4-1170

Overall Length: 134mm

Titanium



Lester Lens Manipulator

Titanium

ST4-1371 Straight

Overall Length: 118mm

ST4-1372 Angled

Overall Length: 115mm

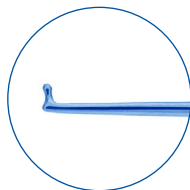

Sinsky Hook

Titanium

ST4-1386 Straight

Overall Length: 115mm

ST4-1387 Angled

Overall Length: 115mm

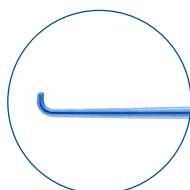

Castroviejo Caliper

ST4-1455

Overall Length: 87mm

Titanium



Buratto Flap Protector

ST4-1660

Overall Length: 114mm

Titanium



Katzen LASIK Flap Unzipper

ST4-1665

Overall Length: 112mm

Titanium



Seibel II Intralase Flap Lifter & Retreatment Spatula

ST4-1720

Overall Length: 104mm

Titanium



Desmarres Chalazion Forceps

ST5-1025

Overall Length: 90mm

Titanium



Francis Chalazion Forceps

ST5-1045

Overall Length: 97mm

Titanium



Barraquer Cilia Forceps

ST5-1085

Overall Length: 108mm

Titanium

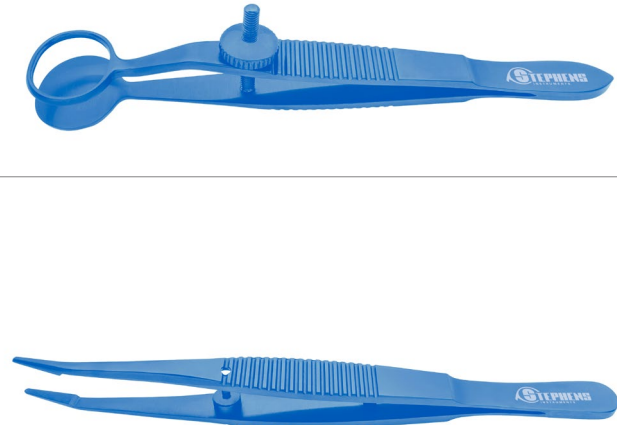
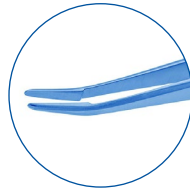

Colibri Forceps

ST5-1120

Overall Length: 75mm

Titanium

0.12mm

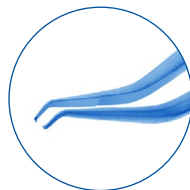

Colibri Forceps

ST5-1125

Overall Length: 77mm

Titanium

.12mm Tip

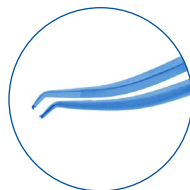

Castroviejo Colibri

ST5-1145

Overall Length: 108mm

Titanium

0.12mm

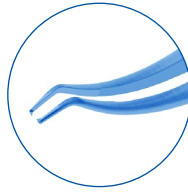

Bonn Forceps

ST5-1245

Overall Length: 85mm

Titanium

0.12mm

Long Model

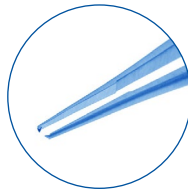

Bonn Forceps

ST5-1250

Overall Length: 76mm

Straight

Serrated Tip

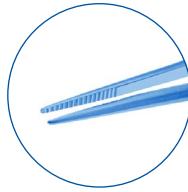

Bishop-Harmon Iris Forceps

Titanium, 1x2 Teeth

ST5-1365 0.8mm

Overall Length: 88mm

ST5-1370 0.3mm

Overall Length: 87mm

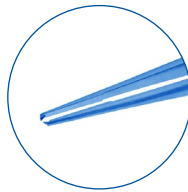
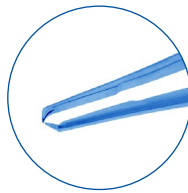

Troutman Superior Rectus

ST5-1515

Overall Length: 102mm

Titanium

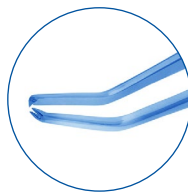

Castroviejo Suturing Forceps

Titanium

ST5-1560 0.12mm

Overall Length: 105mm

ST5-1570 0.3mm

Overall Length: 105mm

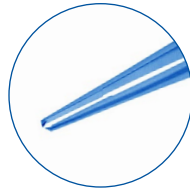
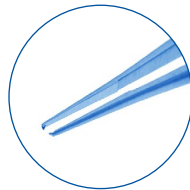
**Utrata Capsulorhexis Forceps****ST5-1601**

Overall Length: 103mm

Titanium

Round Handle

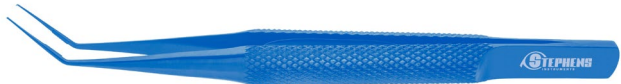
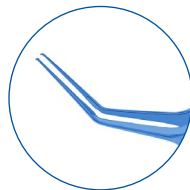
**Masket Capsulorhexis Forceps****ST5-1602**

Overall Length: 103mm

Titanium

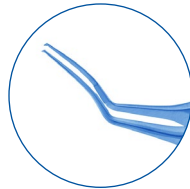
**Utrata Capsulorhexis Forceps****ST5-1603**

Overall Length: 104mm

Titanium

**Utrata Capsulorhexis Forceps****ST5-1611**

Overall Length: 105mm

Titanium

Inamura, Cross-Action

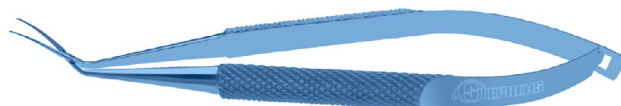
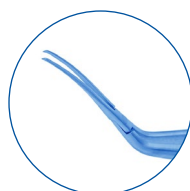

Micro-Incision Capsulorhexis Forceps

ST5-1612

Overall Length: 104mm
Titanium
2mm Depth Control

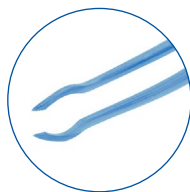

MICS Capsulorhexis Forceps

ST5-1613

Overall Length: 104mm
Titanium
Guide Marks

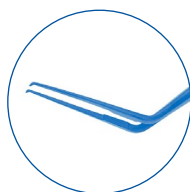

Kelman-McPherson Tying Forceps

ST5-1630

Overall Length: 107mm
Titanium

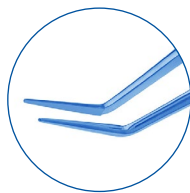

McPherson Tying Forceps

Titanium

ST5-1650

Straight

Overall Length: 109mm

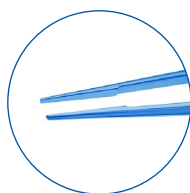

ST5-1655

Angled

Overall Length: 109mm

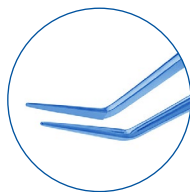

Tennant Tying Forceps

Titanium

ST5-1670 Straight

Overall Length: 103mm

ST5-1675 Curved

Overall Length: 102mm

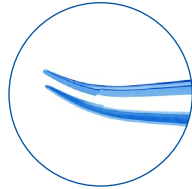
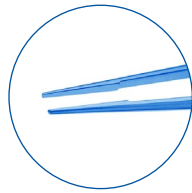

Stephens Soft IOL Insertion Forceps

ST5-1802

Overall Length: 107mm

Titanium



Humer Lens Folding Forceps

ST5-1804

Overall Length: 110mm

Titanium



Akahoshi Pre-Chop

ST5-1903C

Overall Length: 120mm

Titanium



Barraquer Needle Holder

ST6-1000

Overall Length: 137mm

Titanium

Standard Jaws

Curved, without Lock



Barraquer Needle Holder

ST6-1005

Overall Length: 134mm

Standard Jaws

Curved, with Lock



Barraquer Needle Holder

ST6-1006

Overall Length: 118mm

Titanium

Heavy Jaws

Straight, with Lock



Castroviejo Needle Holder

Titanium, Standard Jaws, Straight

ST6-1050 with Lock

Overall Length: 120mm

ST6-1051 without Lock

Overall Length: 122mm



Stephens Needle Holder

Titanium, Delicate Jaws

ST6-1120 Straight, with Lock

Overall Length: 125mm

ST6-1125 Curved, without Lock

Overall Length: 122mm





Microsurgical Instruments

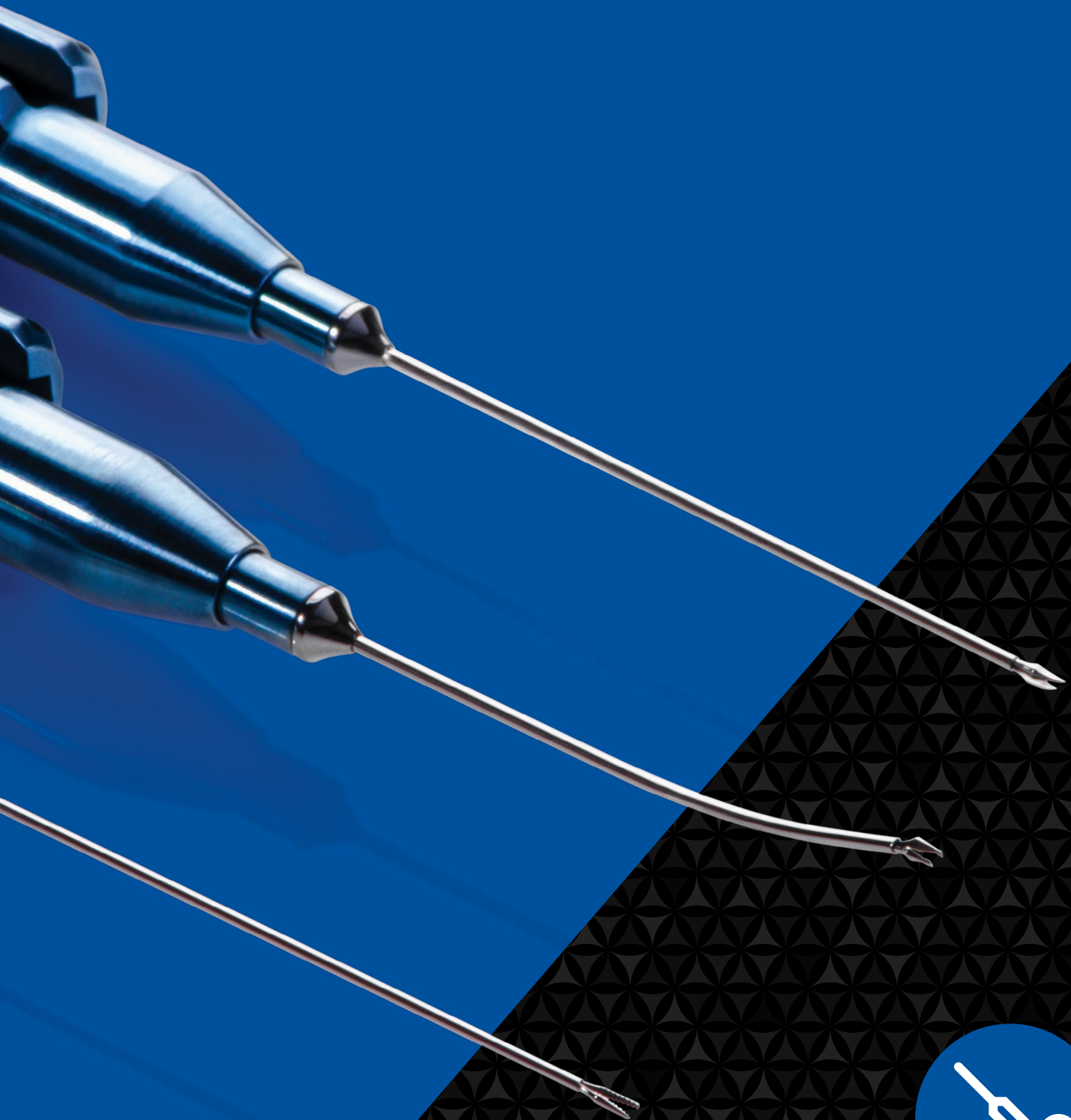

Microsurgical Instruments

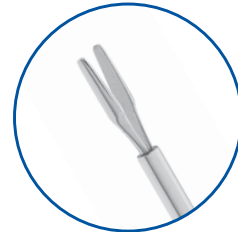
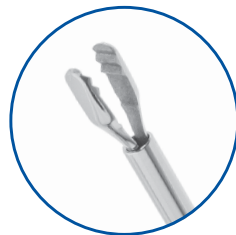
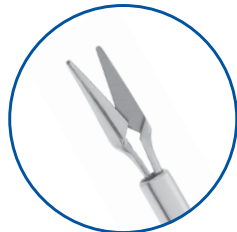
**ST5-7000****ST5-7005****ST5-7010****ST5-7035****ST5-7040****ST5-7050/56****ST5-7060****ST5-7065****ST5-7070****ST7-1410****ST7-1700****ST7-1705****ST7-1710****ST7-1715****ST7-1720**

FORCEPS

Serrated Gripping Forceps, 1.5mm tip	23/25ga	ST5-7000
Micro Gripping Forceps, 3mm tip	23/25ga	ST5-7005
Micro Gripping Forceps, 1.2mm tip	23/25ga	ST5-7010
Capsulorhexis Ultrata Forceps	23ga	ST5-7035
Eckhardt End Gripping Forceps	23ga	ST5-7040
Asymmetrical Forceps	23ga	ST5-7050
Asymmetrical Forceps	25ga	ST5-7056
DSAEK Corneal Forceps	23ga	ST5-7060
ILM Peeling Forceps	23ga	ST5-7065
IOL Holding Forceps, Grooved Jaws	20ga	ST5-7070

SCISSORS

IOL Cutting Scissors	18ga	ST7-1410
Vertical Cutting, 80°	20ga	ST7-1700
Vertical Cutting, 45°	23ga	ST7-1705
Horizontal Cutting, 45°	20ga	ST7-1710
Horizontal Cutting, Curved	23ga	ST7-1715
Horizontal Cutting, Straight, 2.5mm tip	23ga	ST7-1720

Serrated Gripping Forceps

Titanium, 1.5mm Tip

ST5-7000-23 23ga

Overall Length: 144mm

ST5-7000-25 25ga

Overall Length: 144mm



Micro Gripping Forceps

Titanium, 3mm Tip

ST5-7005-23 23ga

Overall Length: 153mm

ST5-7005-25 25ga

Overall Length: 153mm

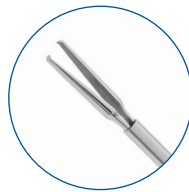

Micro Gripping Forceps

Titanium, 1.2mm Tip

ST5-7010-23 23ga

Overall Length: 144mm

ST5-7010-25 25ga

Overall Length: 144mm

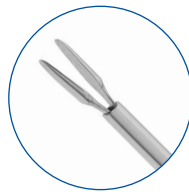

Capsulorhexis Utrata Forceps

ST5-7035

Overall Length: 150mm

Titanium

23ga



Eckhardt End Gripping Forceps

ST5-7040

Overall Length: 144mm

Titanium

23ga

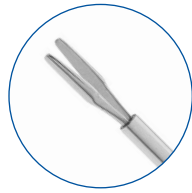

Asymmetrical Forceps

Titanium

ST5-7050 23ga

Overall Length: 138mm

ST5-7056 25ga

Overall Length: 138mm



DSAEK Corneal Forceps

ST5-7060

Overall Length: 150mm

Titanium

23ga



ILM Peeling Forceps

ST5-7065

Overall Length: 144mm

Titanium

23ga

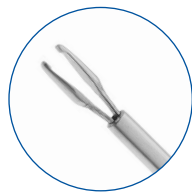

IOL Holding Forceps

ST5-7070

Overall Length: 141mm

Titanium

20ga

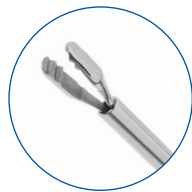

IOL Cutting Scissors

ST7-1410

Overall Length: 143mm

Titanium

18ga



Vertical Cutting Scissors, 80 Degree

ST7-1700

Overall Length: 143mm

Titanium

20ga



Vertical Cutting Scissors, 45 Degree

ST7-1705

Overall Length: 142mm

Titanium

23ga



Horizontal Cutting Scissors, 45 Degree

ST7-1710

Overall Length: 144mm

Titanium

20ga

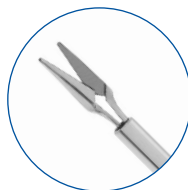

Horizontal Cutting Scissors

Titanium, 23ga

ST7-1715 Curved

Overall Length: 150mm

ST7-1720 Straight

Overall Length: 144mm

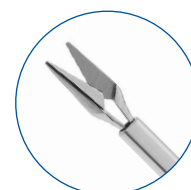
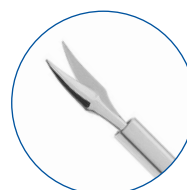



Instrument Sets

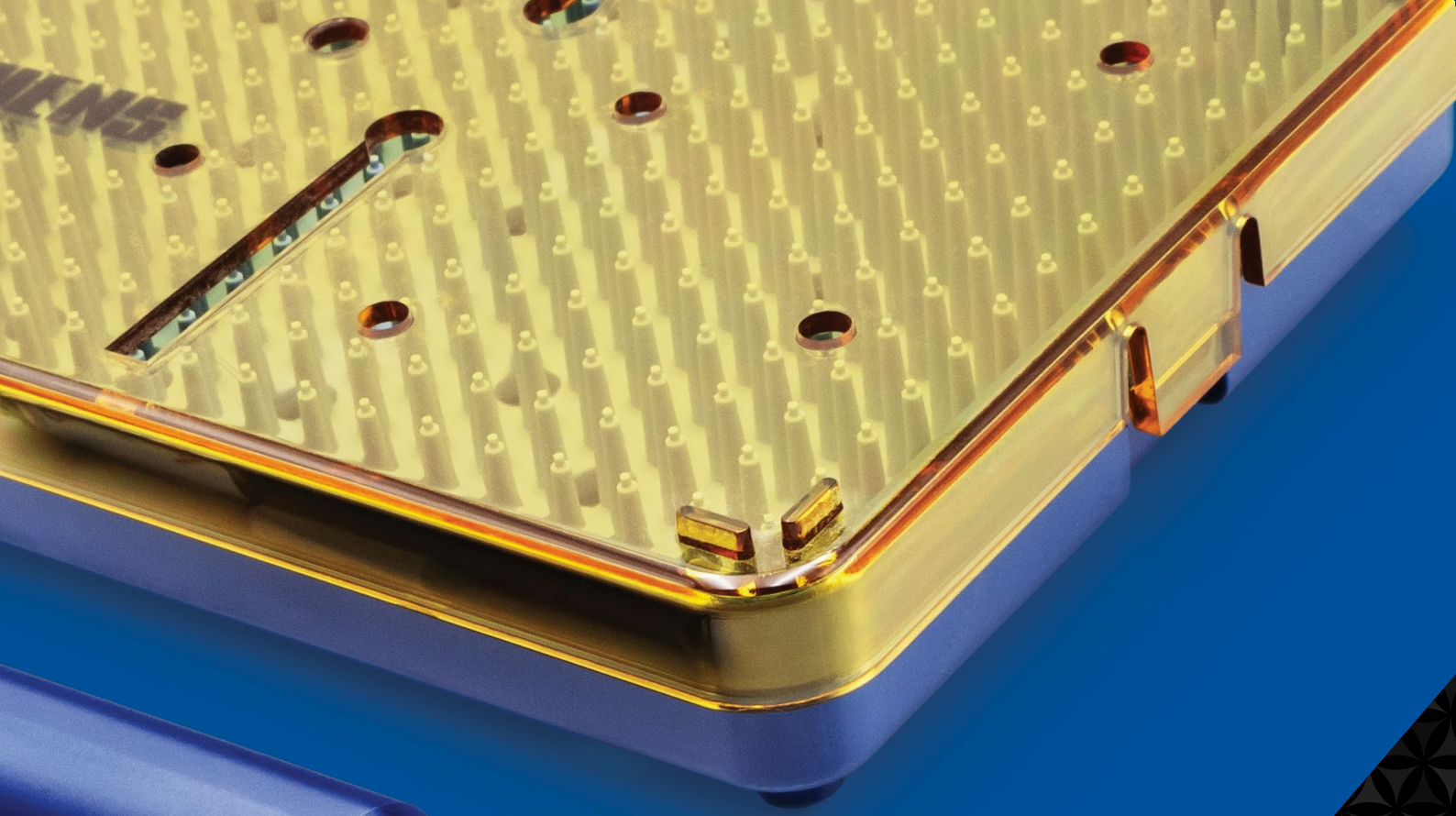

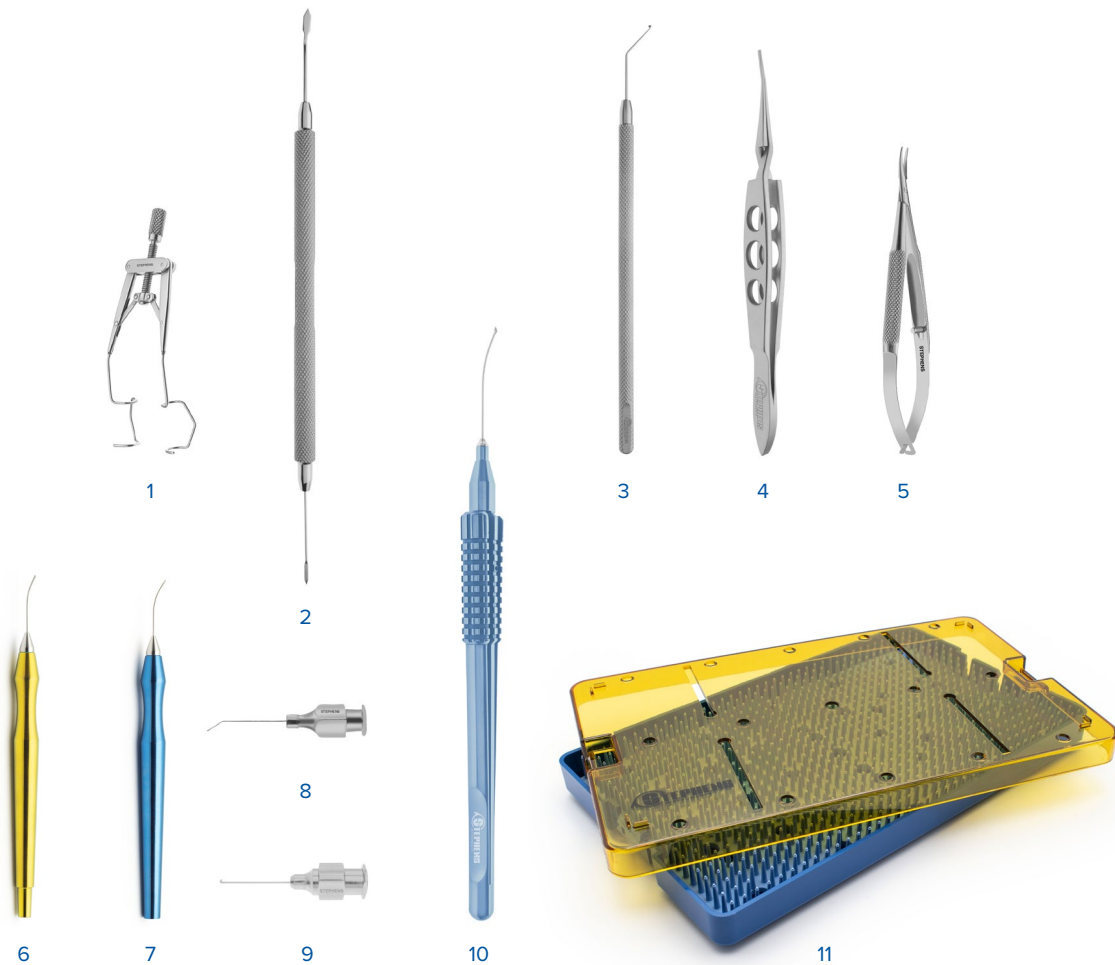

Femto Cataract Set

- | | | |
|----|-----------------|--|
| 1 | S1-1027 | Lieberman Speculum |
| 2 | S4-1700 | Double Ended Femtosecond Spatula |
| 3 | S4-1710 | Solomon Femto Chopper |
| 4 | S5-1535 | Femto LRI Enhancement Forceps |
| 5 | S6-1040 | Barraquer Short Needle Holder |
| 6 | SC-1004 | Bi-Manual Aspiration Cannula, 23ga |
| 7 | SC-1004A | Bi-Manual Irrigating Cannula, 23ga |
| 8 | SC-1630 | Air Injection Cannula, Smooth Angled Tip, 27Ga |
| 9 | SC-5335 | Chang Hydrodissection Cannula |
| 10 | ST5-7035 | Titanium Capsulorhexis Utrata Forceps, 23Ga |
| 11 | T1-0005 | Plastic Instrument Tray, 6" x 10" x 0.75" |

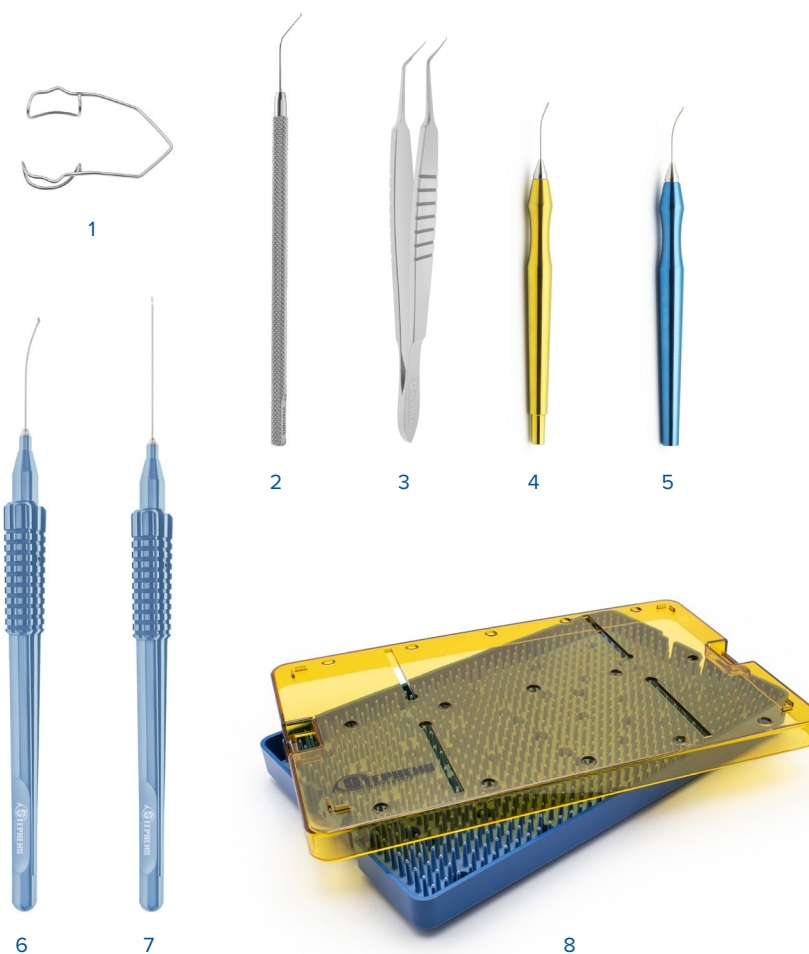

Micro Incision Cataract Set (MICS)

- | | | |
|---|-----------------|---|
| 1 | S1-1020 | Grandon-Barraquer Speculum |
| 2 | S4-1372 | Lester Lens Manipulator, Angled |
| 3 | S5-1613 | Mics Capsulorhexis Forceps, Sharp Tip, With Guide Marks |
| 4 | SC-1004 | Bi-Manual Aspiration Cannula, 23ga |
| 5 | SC-1004A | Bi-Manual Irrigating Cannula, 23ga |
| 6 | ST5-7035 | Titanium Capsulorhexis Utrata Forceps, 23Ga |
| 7 | ST7-1715 | Titanium Horizontal Cutting Scissors, Curved, 23Ga |
| 8 | T1-0005 | Plastic Instrument Tray, 6" x 10" x 0.75" |

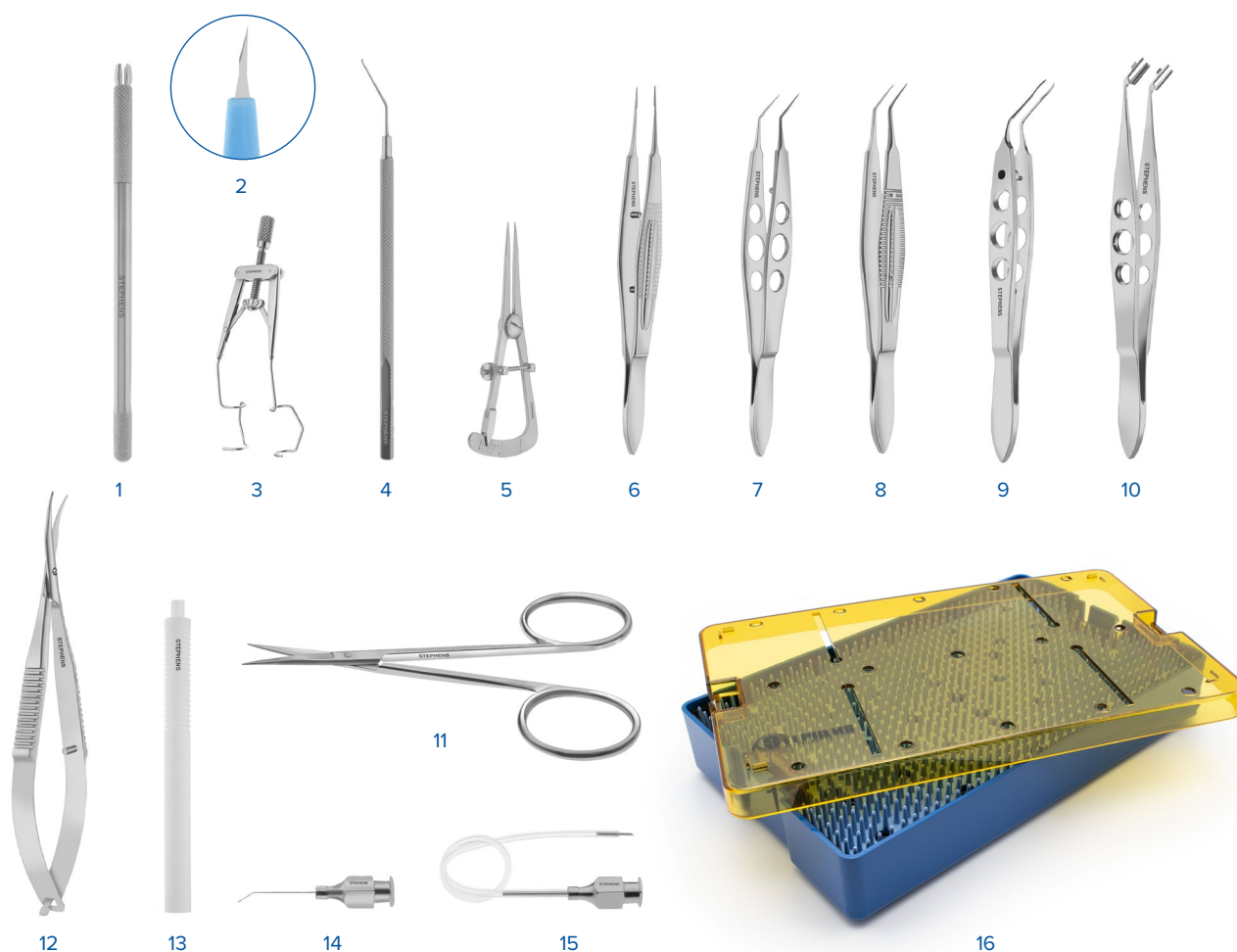

Cataract – Manual

- | | | |
|----|----------------|--|
| 1 | AD-1036 | Blade Handle, 3-Piece For Beaver |
| 2 | R-1500 | 15 Degree Stab Knife |
| 3 | S1-1027 | Lieberman Speculum |
| 4 | S4-1370 | Kuglen Iris Hook Push-Pull Model, Angled |
| 5 | S4-1455 | Castroviejo Caliper, Straight, 20mm |
| 6 | S5-1560 | Castroviejo Suturing Forceps, 0.12mm, With Tying Platform |
| 7 | S5-1603 | Utrata Capsulorhexis Forceps, Flat Handle |
| 8 | S5-1605 | Gaskin Fragment Forceps, 11mm Jaws, With Platform, Very Delicate |
| 9 | S5-1802 | Stephens Soft Iol Insertion Forceps |
| 10 | S5-1804 | Humer Lens Folding Forceps |
| 11 | S7-1035 | Large Ring Scissors, Standard, Straight |
| 12 | S7-1325 | Westcott Tenotomy Scissors, Standard Blades, Blunt |
| 13 | SC-1180 | Infusion Hand Piece, Plastic, Autoclaveable |
| 14 | SC-1630 | Air Injection Cannula, Smooth Angled Tip, 27Ga |
| 15 | SC-1887 | Stephens A/C Maintainer |
| 16 | T2-0005 | Plastic Instrument Tray, 6" x 10" x 1.5" (Double Level) |

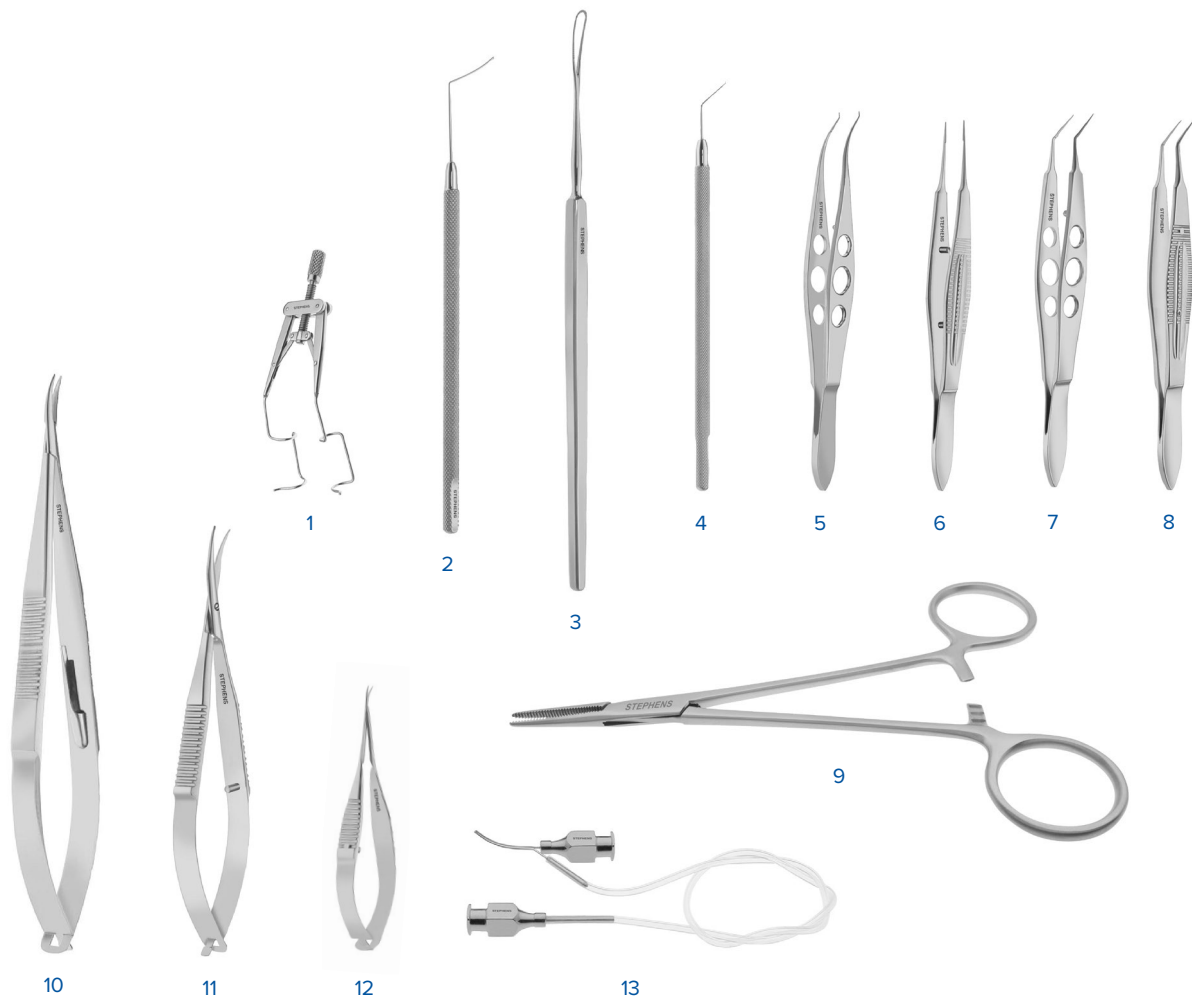

Cataract – MSICS

- 1 **S1-1026** Lieberman Adjustable Eye Speculum, K-Shaped Wire
- 2 **S4-1040** Barraquer Iris Spatula, Smooth, Round
- 3 **S4-1185** Wilder Serrated Lens Loop
- 4 **S4-1387** Sinskey II Lens Hook, 0.18mm Tip, Angled
- 5 **S5-1145** Castroviejo Colibri Forceps, 0.12mm, With Tying Platform
- 6 **S5-1560** Castroviejo Suturing Forceps, 0.12mm, With Tying Platform
- 7 **S5-1603** Utrata Capsulorhexis Forceps, Flat Handle
- 8 **S5-1605** Gaskin Fragment Forceps, 11mm Jaws, With Platform, Very Delicate
- 9 **S5-1915** Mosquito Hemostat, 12.5Cm, Straight
- 10 **S6-1075** Castroviejo Needle Holder, Curved, With Lock, Delicate Jaws
- 11 **S7-1325** Westcott Tenotomy Scissors, Standard Blades, Blunt
- 12 **S7-1375** Vannas Capsulotomy Scissors, Curved, Sharp
- 13 **SC-1906** Simcoe Double Barrel I/A Cannula, 0.3mm Port, 23Ga

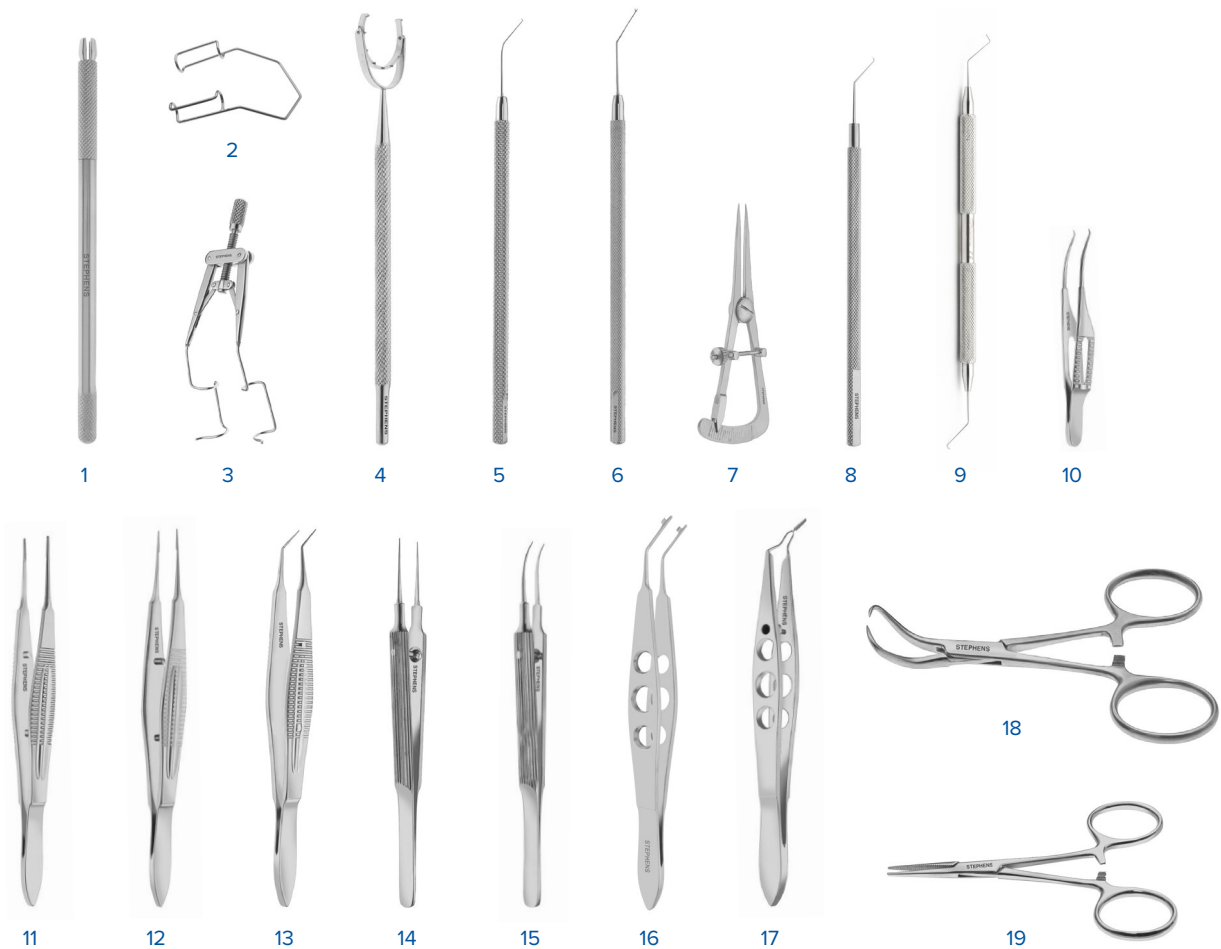

Extracap using Phaco

- | | | |
|----|-----------------|--|
| 1 | AD-1036 | Blade Handle, 3-Piece For Beaver |
| 2 | S1-1012 | Barraquer Wire Speculum, Adult, Temporal, 15mm |
| 3 | S1-1026 | Lieberman Adjustable Eye Speculum, K-Shaped Wire |
| 4 | S1-1211A | Thornton Fixation Ring, 12mm Swinging Handle, Open Ring 1/2 |
| 5 | S4-1372 | Lester Lens Manipulator, Angled |
| 6 | S4-1392 | Jaffe-Maltzman Lens Hook, V Shaped Tip, Angled |
| 7 | S4-1455 | Castroviejo Caliper, Straight, 20mm |
| 8 | S4-1550 | Nagahara Horizontal Chopper |
| 9 | S4-1554 | Chang-Seibel Chopper |
| 10 | S5-1120 | Barraquer Colibri Forceps, 0.12mm With Tying Platform |
| 11 | S5-1355 | Macgregor Conjunctiva Forceps, 6mm Tying Platform, Serrated Tips |
| 12 | S5-1560 | Castroviejo Suturing Forceps, 0.12mm, With Tying Platform |
| 13 | S5-1630 | Kelman-Mcpherson Tying Forceps, 8mm, Angled |
| 14 | S5-1670 | Tennant Tying Forceps, Round Hand, Straight, With Platform |
| 15 | S5-1675 | Tennant Tying Forceps, Round Hand, Curved, With Platform |
| 16 | S5-1794M | Livernois Lens Forceps, Modified |

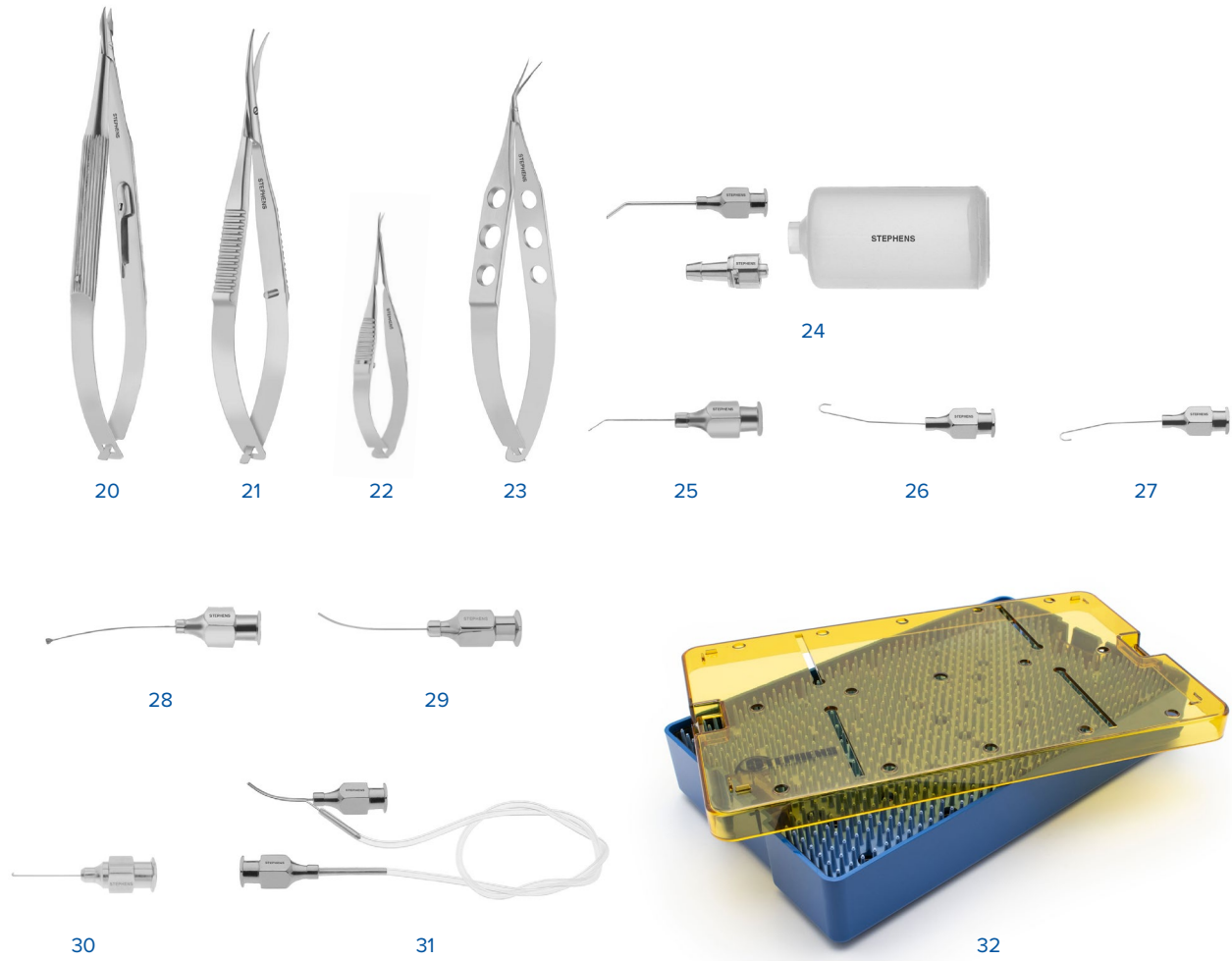

- 17 **S5-1798** Cross Action Lens Folding Forceps
- 18 **S5-1904A** Backhaus Towel Clamp
- 19 **S5-1905** Mosquito Hemostat, 9Cm, Straight
- 20 **S6-1130** Stephens Needle Holder, Curved, With Lock, Very Delicate Jaws
- 21 **S7-1325** Westcott Tenotomy Scissors, Standard Blades, Blunt
- 22 **S7-1375** Vannas Capsulotomy Scissors, Curved, Sharp
- 23 **S7-1384** Stern-Gills Vannas Scissors, 11mm Blades
- 24 **SC-1005** Bishop-Harmon Anterior Chamber Irrigator, Complete Set
- 25 **SC-1630** Air Injection Cannula, Smooth Angled Tip, 27Ga
- 26 **SC-1820** Binkhorst Irrigating Hooked Cannula, 22Ga, Left
- 27 **SC-1825** Binkhorst Irrigating Hooked Cannula, 22Ga, Right
- 28 **SC-1835** Jensen Post.Cap. Polisher, Sandblasted Tip, 23Ga
- 29 **SC-1906** Simcoe Double Barrel I/A Cannula, 0.3mm Port, 23Ga
- 30 **SC-5335** Chang Hydrodissection Cannula
- 31 **SC-5360** Sauter Nucleus Hydrodissector
- 32 **T2-0005** Plastic Instrument Tray, 6" x 10" x 1.5" (Double Level)

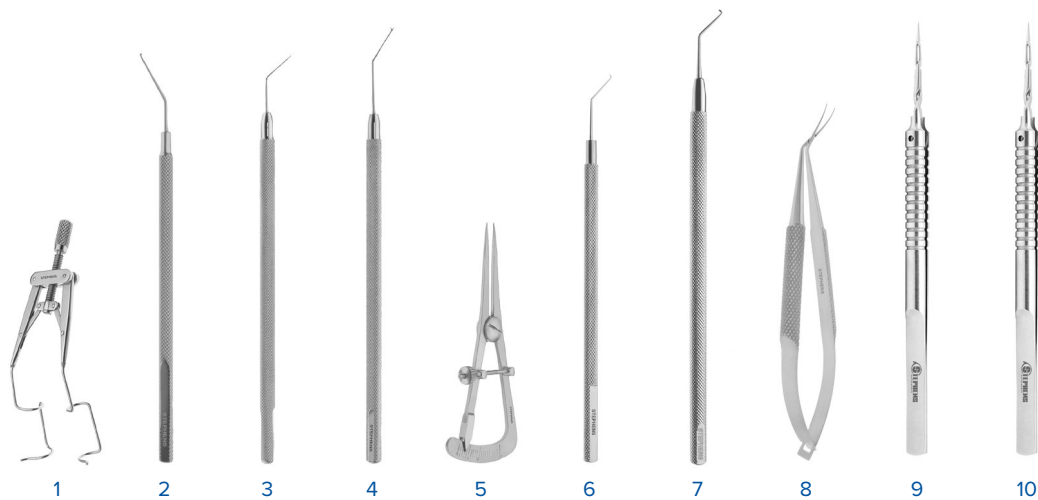

Phaco Prechop Set

- | | | |
|----|-----------------|--|
| 1 | S1-1026 | Lieberman Adjustable Eye Speculum, K-Shaped Wire |
| 2 | S4-1370 | Kuglen Iris Hook Push-Pull Model, Angled |
| 3 | S4-1387 | Sinsky li Lens Hook, 0.18mm Tip, Angled |
| 4 | S4-1392 | Jaffe-Maltzman Lens Hook, V Shaped Tip, Angled |
| 5 | S4-1455 | Castroviejo Caliper, Straight, 20mm |
| 6 | S4-1550 | Nagahara Horizontal Chopper |
| 7 | S4-1556 | Rosen Phaco Splitter |
| 8 | S5-1611 | Capsulorhexis Forceps, Inamura Style |
| 9 | S5-1903 | Stephens Phaco Pre-Splitter |
| 10 | S5-1903C | Akahoshi Pre-Chop, Combo Jaws |

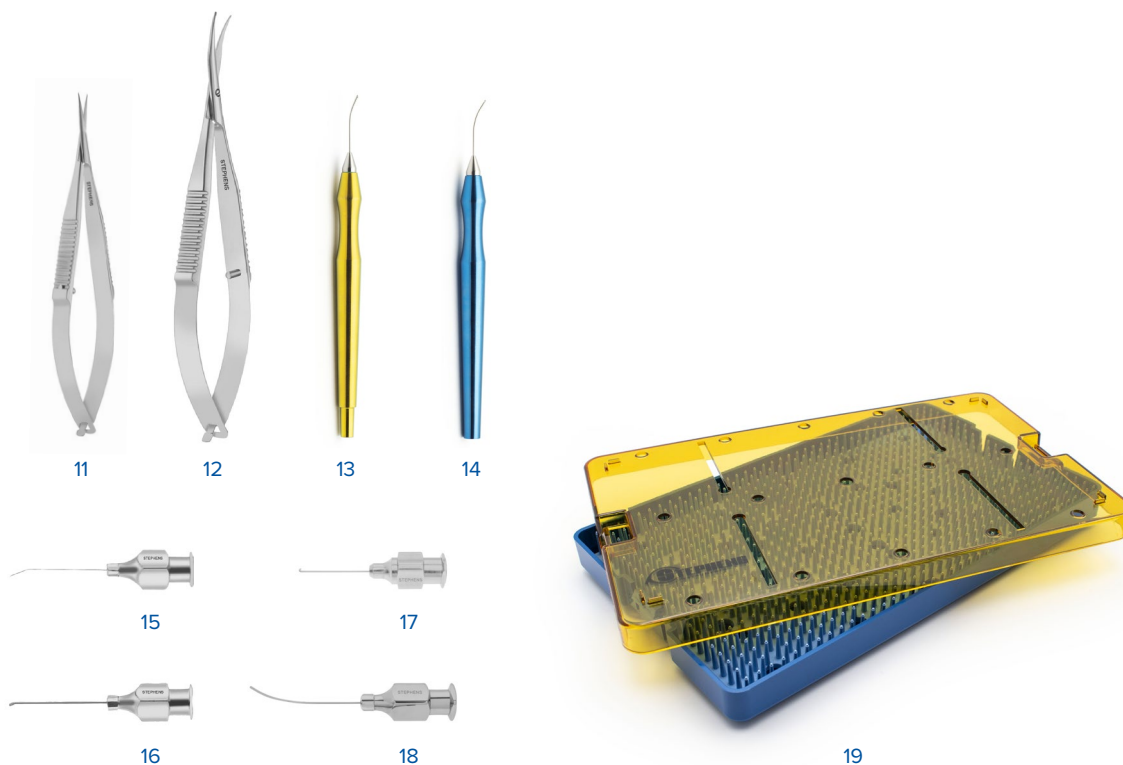

- 11 **S7-1315** Westcott Tenotomy Stitch Scissors, Standard Blades, Extra Sharp Tips
- 12 **S7-1325** Westcott Tenotomy Scissors, Standard Blades, Blunt
- 13 **SC-1004** Bi-Manual Aspiration Cannula, 23ga
- 14 **SC-1004A** Bi-Manual Irrigating Cannula, 23ga
- 15 **SC-1625** Air Injection Cannula, Smooth Angled Tip, 30Ga
- 16 **SC-1865** Kratz Capsule Wall Scraper, 1mm Angled, 23Ga
- 17 **SC-5335** Chang Hydrodissection Cannula
- 18 **SC-5360** Sauter Nucleus Hydrodissector
- 19 **T1-0005** Plastic Instrument Tray, 6" x 10" x 0.75"

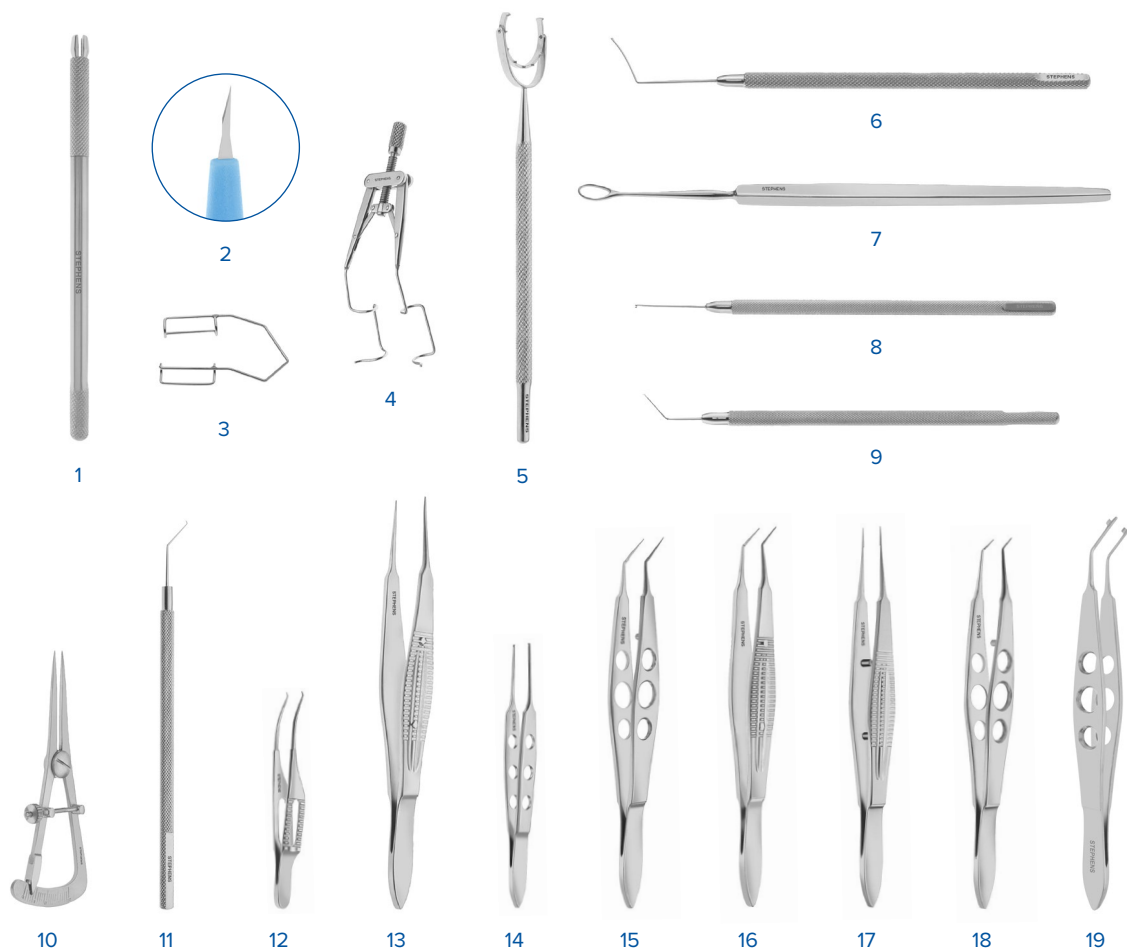

Planned Ecce Cataract

- | | | |
|----|-----------------|--|
| 1 | AD-1036 | Blade Handle, 3-Piece For Beaver |
| 2 | R-1500 | 15 Degree Stab Knife |
| 3 | S1-1005 | Barraquer Wire Speculum, Adult, 15mm |
| 4 | S1-1026 | Lieberman Adjustable Eye Speculum, K-Shaped Wire |
| 5 | S1-1211A | Thornton Fixation Ring, 12mm Swinging Handle, Open Ring 1/2 |
| 6 | S4-1040 | Barraquer Iris Spatula, Smooth, Round |
| 7 | S4-1165 | Lewis Lens Loop, Large |
| 8 | S4-1365 | Kuglen Iris Hook Push-Pull Model, Straight |
| 9 | S4-1387 | Sinsky li Lens Hook, 0.18mm Tip, Angled |
| 10 | S4-1455 | Castroviejo Caliper, Straight, 20mm |
| 11 | S4-1550 | Nagahara Horizontal Chopper |
| 12 | S5-1120 | Barraquer Colibri Forceps, 0.12mm With Tying Platform |
| 13 | S5-1240 | Bonn Forceps, 1X2 Teeth, 0.12mm, Long Model |
| 14 | S5-1365 | Bishop-Harmon Iris Forceps, 1X2 Teeth Standard, 0.8mm |
| 15 | S5-1603 | Utrata Capsulorhexis Forceps, Flat Handle |
| 16 | S5-1630 | Kelman-Mcpherson Tying Forceps, 8mm, Angled |
| 17 | S5-1650 | Mcpherson Tying Forceps, Long Model, Straight, With Platform |
| 18 | S5-1655 | Mcpherson Tying Forceps, Long Model, Angled, With Platform |
| 19 | S5-1794M | Livernois Lens Forceps, Modified |

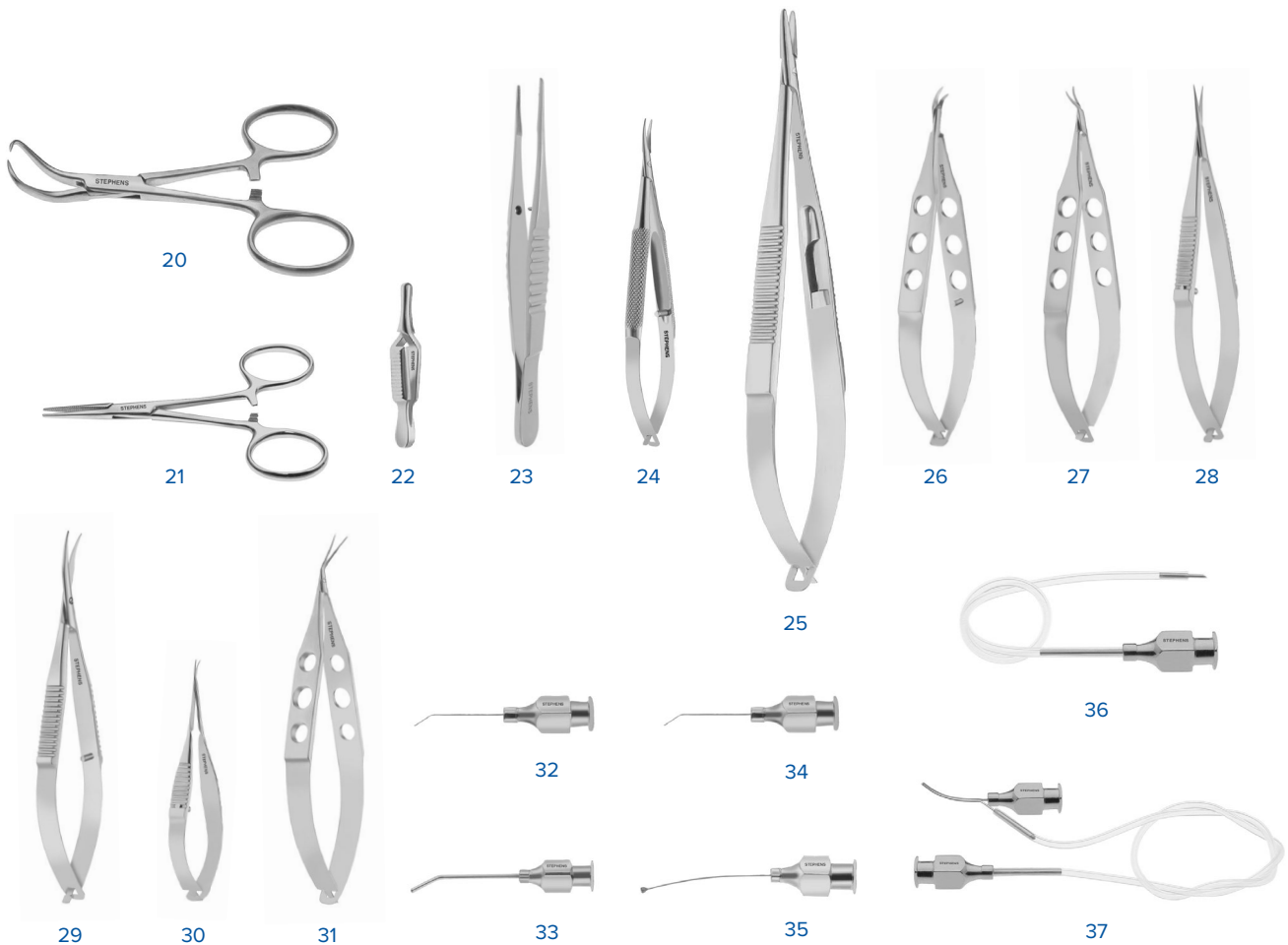

- 20 **S5-1904A** Backhaus Towel Clamp
- 21 **S5-1905** Mosquito Hemostat, 9Cm, Straight
- 22 **S5-1925** Diffenbach Serrefine, 4Cm, Straight
- 23 **S5-1960** Bonaccolto Utility Forceps, Delicate Model
- 24 **S6-1040** Barraquer Short Needle Holder, Curved, Without Lock, Delicate Jaw
- 25 **S6-1050** Castroviejo Needle Holder, Straight, With Lock, Standard Jaws
- 26 **S7-1165** Castroviejo Corneal Section Scissors, Small, Right
- 27 **S7-1170** Castroviejo Corneal Section Scissors, Small, Left
- 28 **S7-1315** Westcott Tenotomy Stitch Scissors, Standard Blades, Extra Sharp Tips
- 29 **S7-1325** Westcott Tenotomy Scissors, Standard Blades, Blunt
- 30 **S7-1375** Vannas Capsulotomy Scissors, Curved, Sharp
- 31 **S7-1384** Stern-Gills Vannas Scissors, 11mm Blades
- 32 **SC-1005** Bishop-Harmon Anterior Chamber Irrigator, Complete Set
- 33 **SC-1315** Healon Aspirating Cannula, Angled, 22Ga
- 34 **SC-1630** Air Injection Cannula, Smooth Angled Tip, 27Ga
- 35 **SC-1835** Jensen Post.Cap. Polisher, Sandblasted Tip, 23Ga
- 36 **SC-1887** Stephens A/C Maintainer
- 37 **SC-1906** Simcoe Double Barrel I/A Cannula, 0.3mm Port, 23Ga

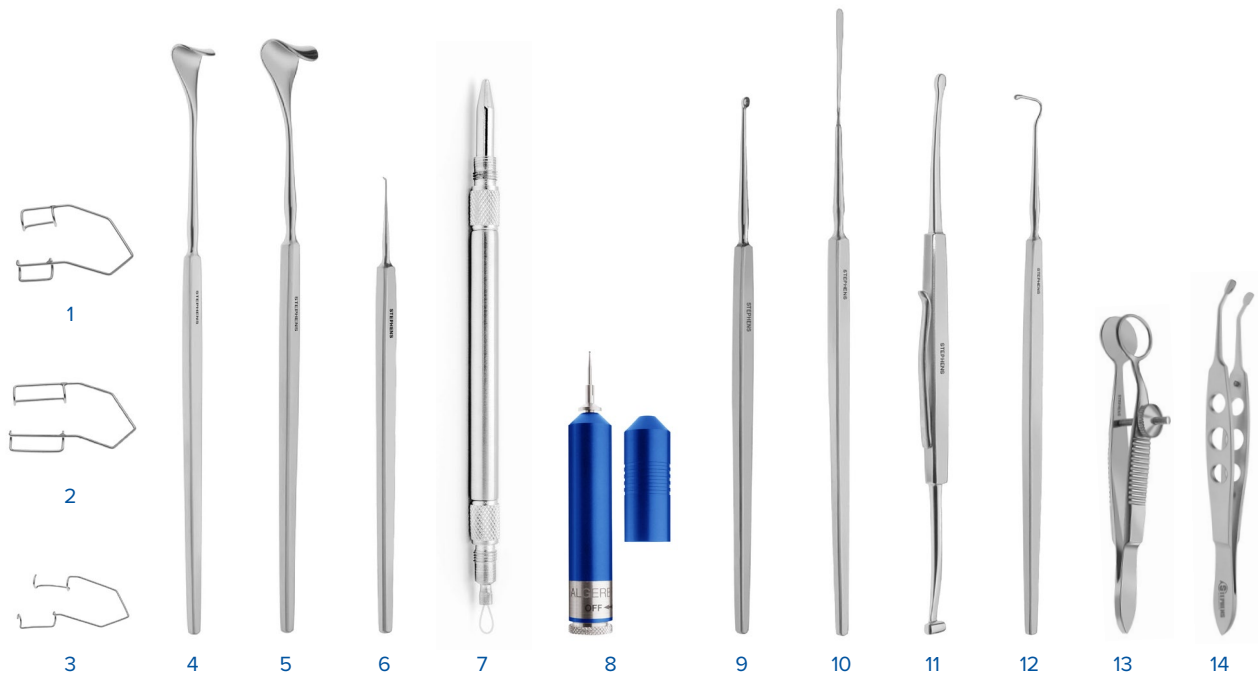

Office Set

- | | | |
|----|----------------|--|
| 1 | S1-1002 | Barraquer Wire Speculum, Child, 12mm |
| 2 | S1-1005 | Barraquer Wire Speculum, Adult, 15mm |
| 3 | S1-1016 | Kratz Wing Speculum, Without Bar, Adult |
| 4 | S1-1220 | Desmarres Lid Retractor #1, 13mm |
| 5 | S1-1225 | Desmarres Lid Retractor #2, 15mm |
| 6 | S2-1135 | Golf Club Foreign Body Spud |
| 7 | S2-1160 | Stephens Eye Loop & Magnet |
| 8 | S2-1170 | Alger Brush, Rust Ring Remover |
| 9 | S4-1015 | Meyerhoefer Chalazion Curette #3, 2.50mm |
| 10 | S4-1155 | Kimura Platinum Spatula |
| 11 | S4-1231 | Schocket Scleral Depressor, Double Ended |
| 12 | S4-1430 | Jameson Muscle Hook, Small |
| 13 | S5-1045 | Francis Chalazion Forceps, 12X14 Inside Diameter |
| 14 | S5-1058 | Stephens Meibomian Gland Expressor |

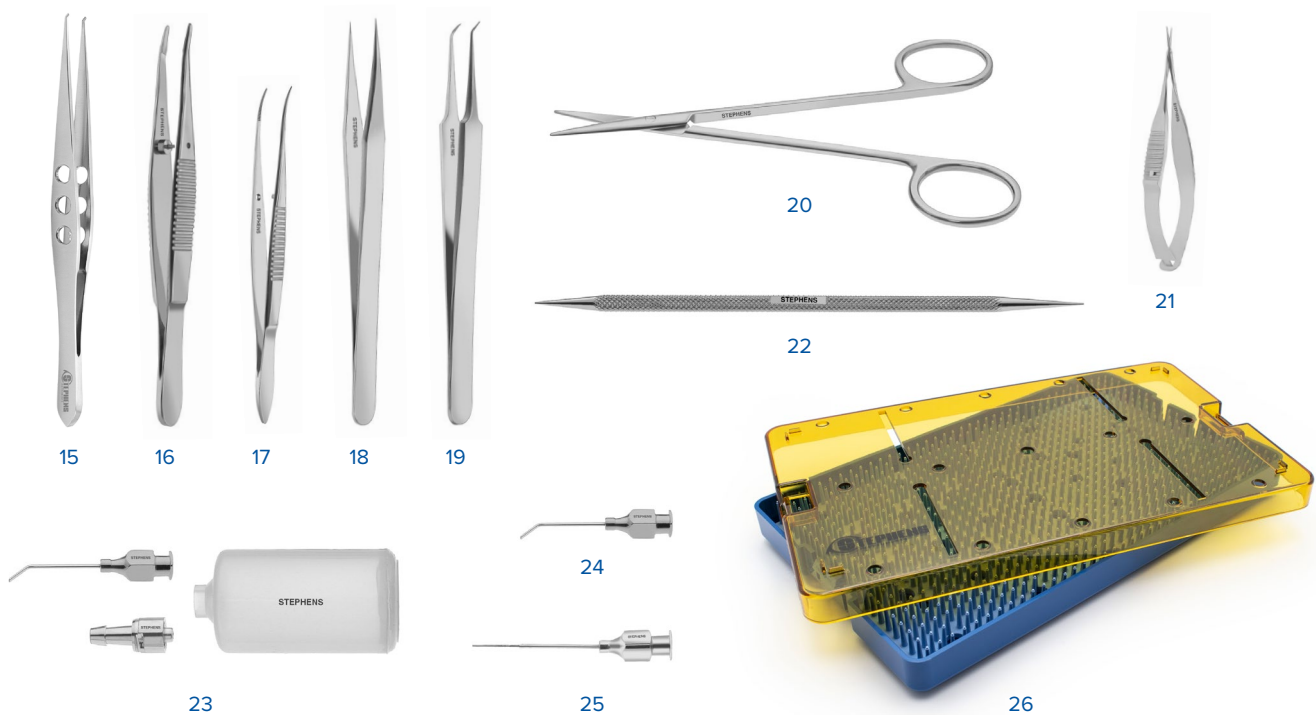

- 15 **S5-1059** Stephens Intra canalicular Plug Forceps
- 16 **S5-1085** Barraquer Cilia Forceps
- 17 **S5-1380** Dressing Forceps, With Guide Pin, Serrated, Curved
- 18 **S5-1700** Jewelers Forceps, #3C, Straight
- 19 **S5-1715** Jewelers Forceps, #5A, Angled
- 20 **S7-1110** Knapp Strabismus Scissors, Straight, Ring Handle
- 21 **S7-1370** Vannas Capsulotomy Scissors, Straight, Sharp
- 22 **S8-1015** Castroviejo Lacrimal Dilator, Medium & Fine Points
- 23 **SC-1005** Bishop-Harmon Anterior Chamber Irrigator, Complete Set
- 24 **SC-1020** Irrigation Cannula 19Ga
- 25 **SC-1530** Lacrimal Cannula, Reinforced, 23Ga Tip, Straight
- 26 **T1-0005** Plastic Instrument Tray, 6" x 10" x 0.75"

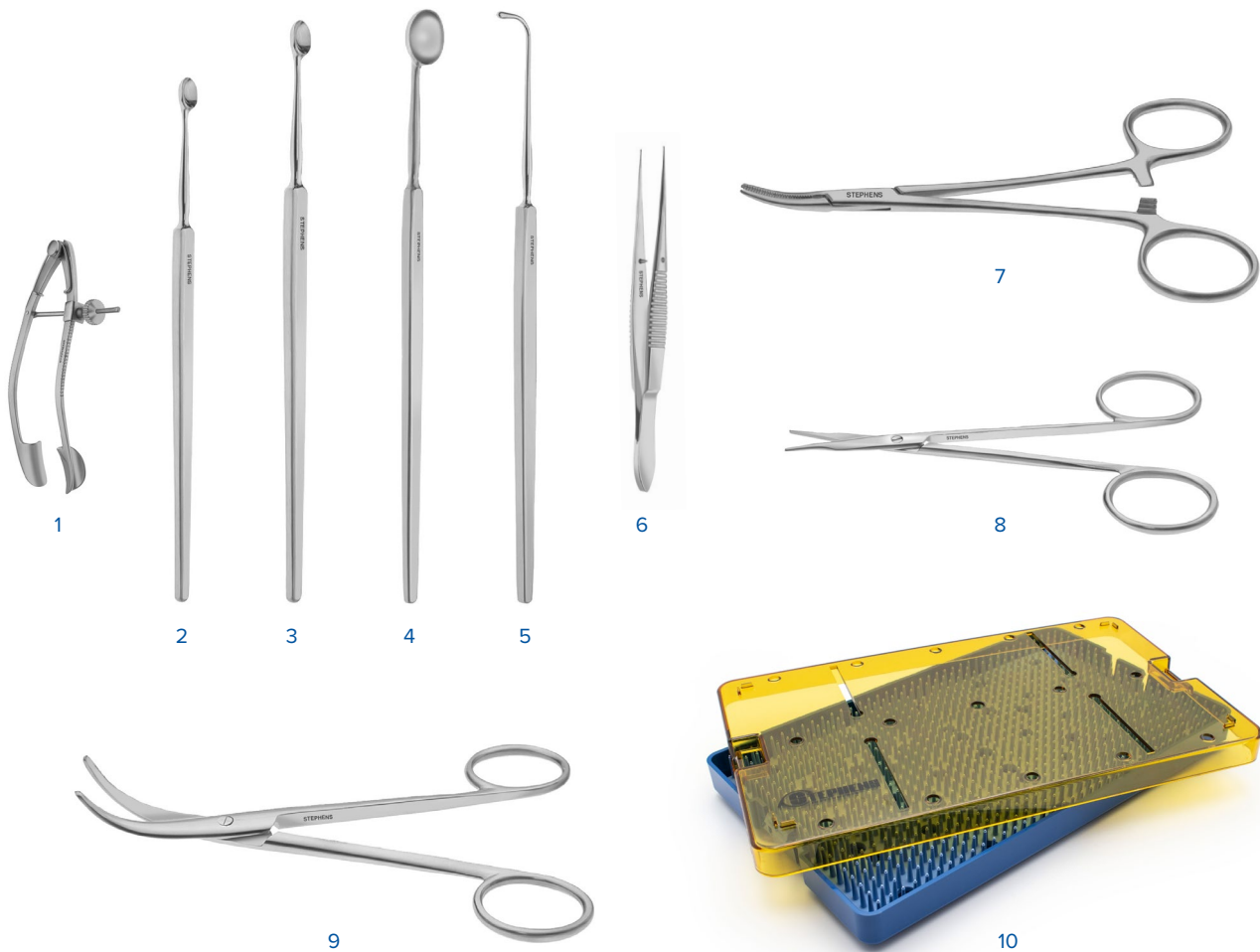

Enucleation Set

- | | | |
|----|----------------|--|
| 1 | S1-1070 | Barraquer Iris Spatula, Smooth, Round |
| 2 | S4-1200 | Bunge Evisceration Spoon, Small |
| 3 | S4-1205 | Bunge Evisceration Spoon, Medium |
| 4 | S4-1210 | Bunge Evisceration Spoon, Large |
| 5 | S4-1415 | Graefe Muscle Hook, Medium #2 |
| 6 | S5-1385 | Tissue Forceps, 1X2 Teeth, Straight |
| 7 | S5-1920 | Mosquito Hemostat, 12.5Cm, Curved |
| 8 | S7-1085 | Stevens Tenotomy Scissors, Standard, Straight, Ring Handle |
| 9 | S7-1135 | Enucleation Scissors, Strong Curve, Ring Handle |
| 10 | T1-0005 | Plastic Instrument Tray, 6" x 10" x 0.75" |

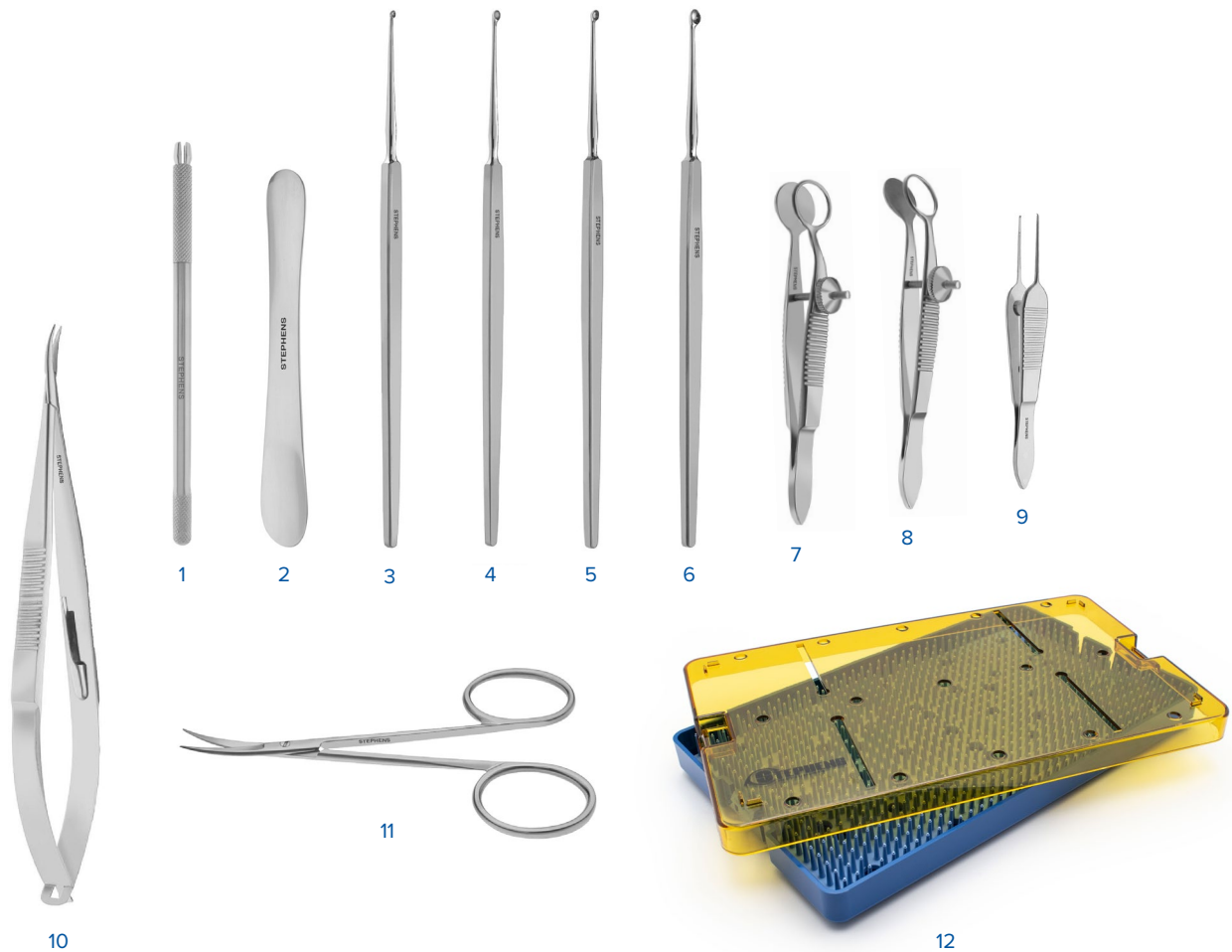

Chalazion

- 1 **AD-1036** Blade Handle, 3-Piece For Beaver
- 2 **S1-1235** Jaeger Lid Plate
- 3 **S4-1005** Meyerhoefer Chalazion Curette #1, 1.75mm
- 4 **S4-1010** Meyerhoefer Chalazion Curette #2, 2.25mm
- 5 **S4-1015** Meyerhoefer Chalazion Curette #3, 2.50mm
- 6 **S4-1020** Meyerhoefer Chalazion Curette #4, 3.50mm
- 7 **S5-1045** Francis Chalazion Forceps, 12X14 Inside Diameter
- 8 **S5-1055** Hunt Chalazion Forceps, 12mm Diameter
- 9 **S5-1668** Manhattan Eye & Ear Forceps
- 10 **S6-1075** Castroviejo Needle Holder, Curved, With Lock, Delicate Jaws
- 11 **S7-1040** Large Ring Scissors, Standard, Curved, Ring Handle
- 12 **T1-0005** Plastic Instrument Tray, 6" x 10" x 0.75"

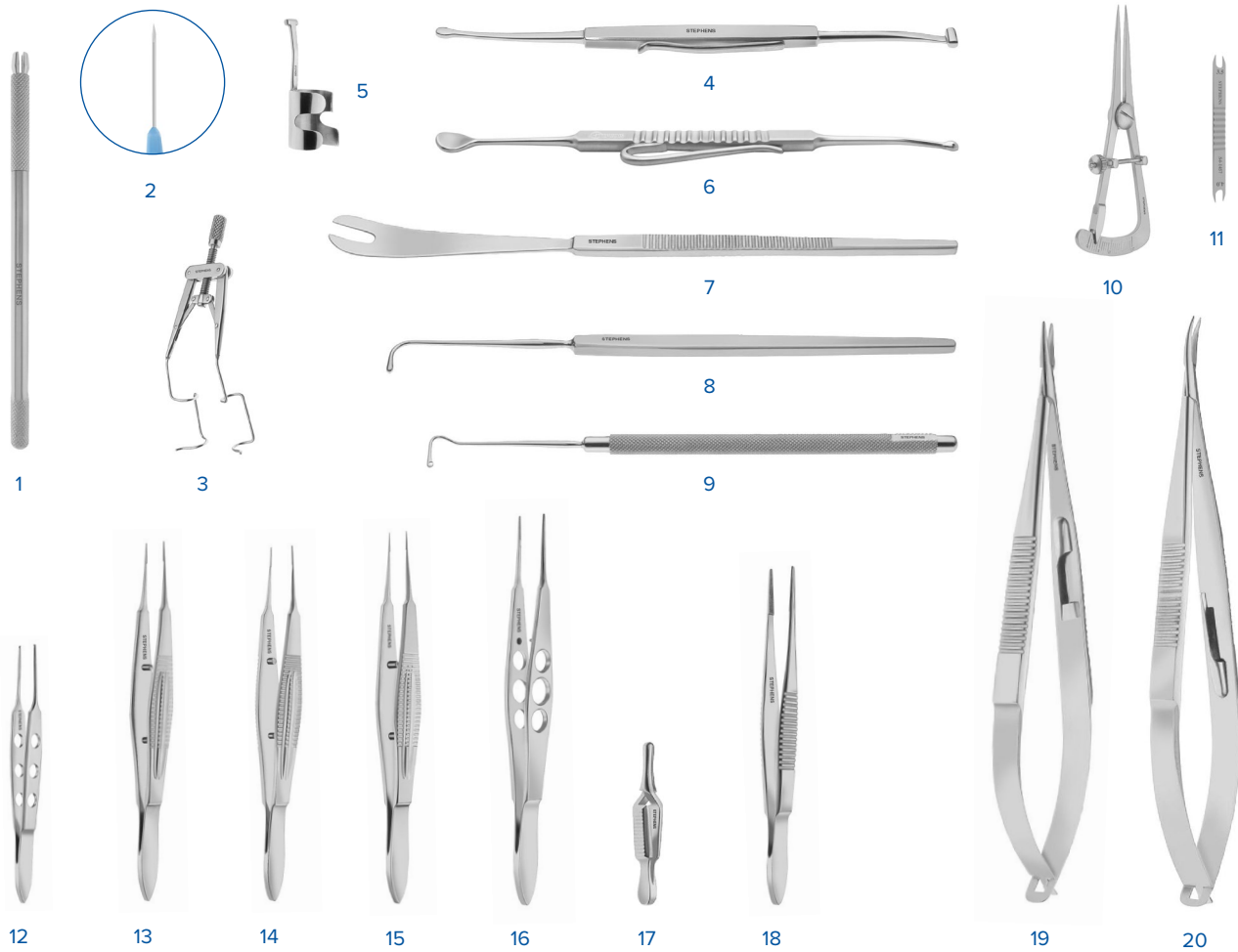

Vitreoretinal 23ga

- | | | |
|----|----------------|---|
| 1 | AD-1036 | Blade Handle, 3-Piece For Beaver |
| 2 | R-5560 | 3.2mm Angle Slit Knife |
| 3 | S1-1026 | Lieberman Adjustable Eye Speculum, K-Shaped Wire |
| 4 | S4-1231 | Schocket Scleral Depressor, Double Ended |
| 5 | S4-1232 | Schepens Scleral Depressor, Thimble |
| 6 | S4-1236 | Josephberg-Besser Scleral Depressor, Double Ended |
| 7 | S4-1260 | Schepens Orbital Retractor |
| 8 | S4-1415 | Graefe Muscle Hook, Medium #2 |
| 9 | S4-1440 | Kirby Muscle Hook |
| 10 | S4-1455 | Castroviejo Caliper, Straight, 20mm |
| 11 | S4-1457 | Braunstein Caliper 3.5/4.0mm |
| 12 | S5-1365 | Bishop-Harmon Iris Forceps, 1X2 Teeth Standard, 0.8mm |
| 13 | S5-1560 | Castroviejo Suturing Forceps, 0.12mm, With Tying Platform |
| 14 | S5-1570 | Castroviejo Suturing Forceps, 0.3mm, With Tying Platform |
| 15 | S5-1650 | Mcperson Tying Forceps, Long Model, Straight, With Platform |
| 16 | S5-1895 | Bonaccolto Utility & Splinter Forceps, Serrated |
| 17 | S5-1925 | Diffenbach Serrefine, 4Cm, Straight |

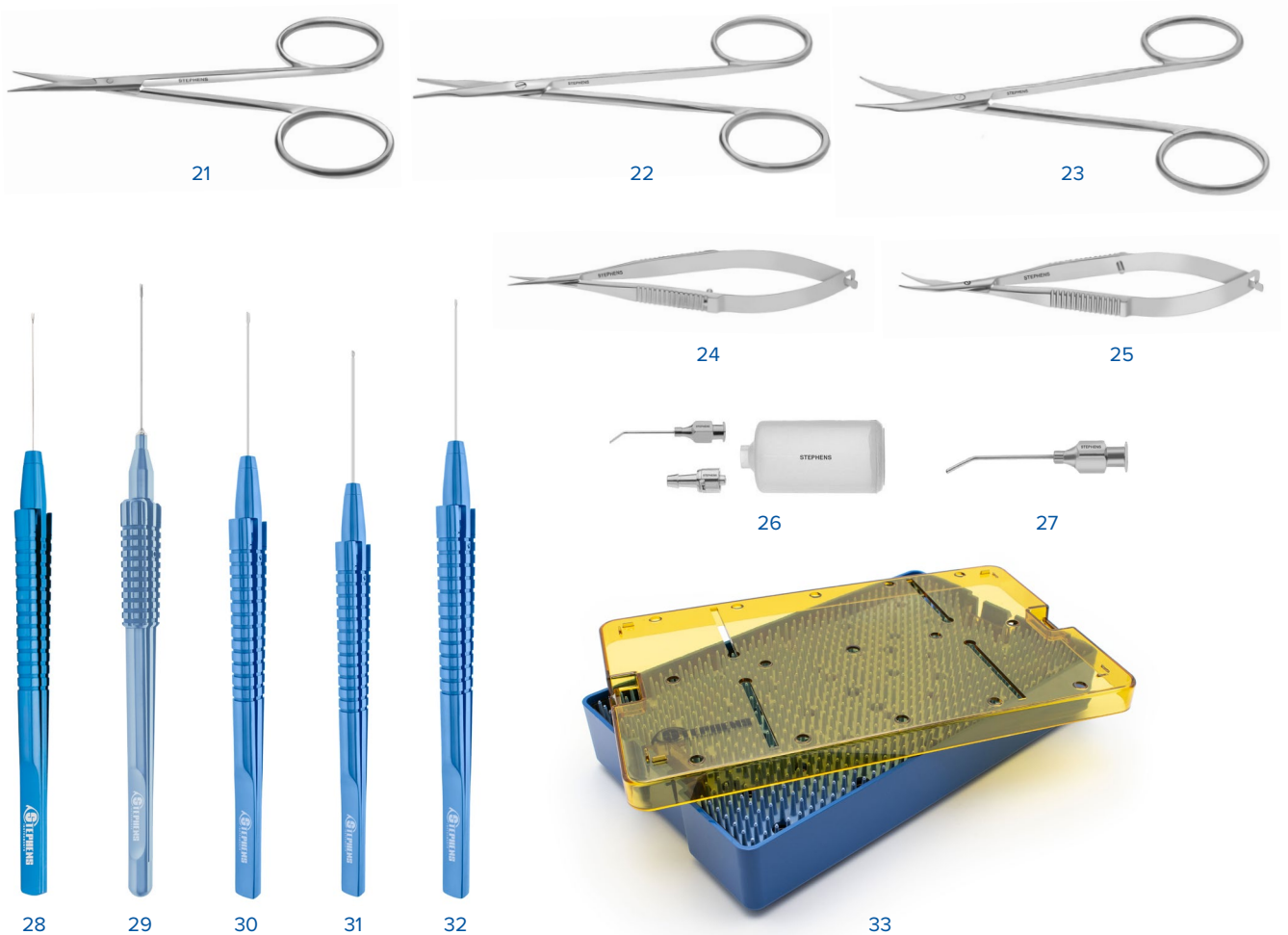

- 18 **S5-1955** Wills Hospital Utility Forceps, Serrated
- 19 **S6-1065** Castroviejo Needle Holder, Straight, With Lock, Delicate Jaws
- 20 **S6-1075** Castroviejo Needle Holder, Curved, With Lock, Delicate Jaws
- 21 **S7-1035** Large Ring Scissors, Standard, Straight
- 22 **S7-1085** Stevens Tenotomy Scissors, Standard, Straight, Ring Handle
- 23 **S7-1090** Stevens Tenotomy Scissors, Standard, Curved, Ring Handle
- 24 **S7-1315** Westcott Tenotomy Stitch Scissors, Standard Blades, Extra Sharp Tips
- 25 **S7-1325** Westcott Tenotomy Scissors, Standard Blades, Blunt
- 26 **SC-1005** Bishop-Harmon Anterior Chamber Irrigator, Complete Set
- 27 **SC-1315** Healon Aspirating Cannula, Angled, 22Ga
- 28 **ST5-7000** Titanium Serrated Gripping Forceps, 1.5mm Tip, 23Ga
- 29 **ST5-7005-23** Titanium Micro Gripping Forceps, 3mm Tip, 23Ga
- 30 **ST5-7010-23** Titanium Micro Gripping Forceps, 1.2mm Tip, 23Ga
- 31 **ST5-7050** Titanium Asymmetrical Forceps, 23Ga
- 32 **ST5-7065** Titanium IIm Peeling Forceps, 23Ga
- 33 **T2-0005** Plastic Instrument Tray, 6" x 10" x 1.5" (Double Level)

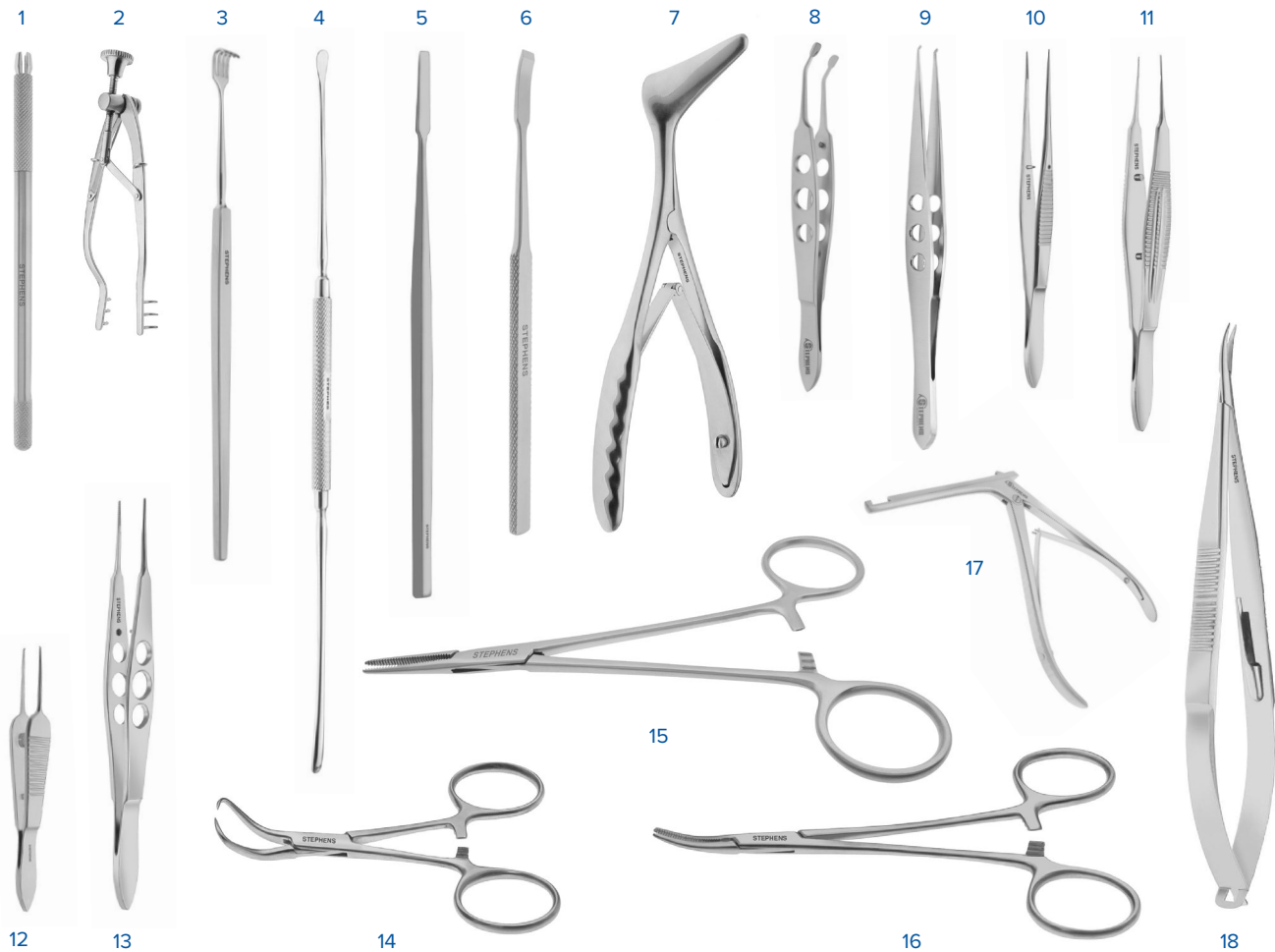

Lacrimal Set

- | | | |
|----|-----------------|---|
| 1 | AD-1036 | Blade Handle, 3-Piece For Beaver |
| 2 | S1-1255 | Stevenson Retractor, 3X3 Prongs |
| 3 | S1-1270 | Knapp Retractor, 4 Prongs, Blunt |
| 4 | S1-1275 | Tenzel Double Ended Periosteal Elevator |
| 5 | S1-1276 | West Lacrimal Chisel, Straight |
| 6 | S1-1277 | West Lacrimal Chisel, Curved |
| 7 | S1-1297 | Nasal Speculum, Adult |
| 8 | S5-1058 | Stephens Meibomian Gland Expressor |
| 9 | S5-1059 | Stephens Intracanalicular Plug Forceps |
| 10 | S5-1375 | Dressing Forceps, With Guide Pin, Serrated, Straight |
| 11 | S5-1570 | Castroviejo Suturing Forceps, 0.3mm, With Tying Platform |
| 12 | S5-1666 | Sauer Suture Forceps, 1X2, Oblique Angled |
| 13 | S5-1895 | Bonaccolto Utility & Splinter Forceps, Serrated |
| 14 | S5-1904A | Backhaus Towel Clamp |
| 15 | S5-1915 | Mosquito Hemostat, 12.5Cm, Straight |
| 16 | S5-1920 | Mosquito Hemostat, 12.5Cm, Curved |
| 17 | S5-1990 | Kerrison Rongeur Forceps, Size 1 |
| 18 | S6-1075 | Castroviejo Needle Holder, Curved, With Lock, Delicate Jaws |

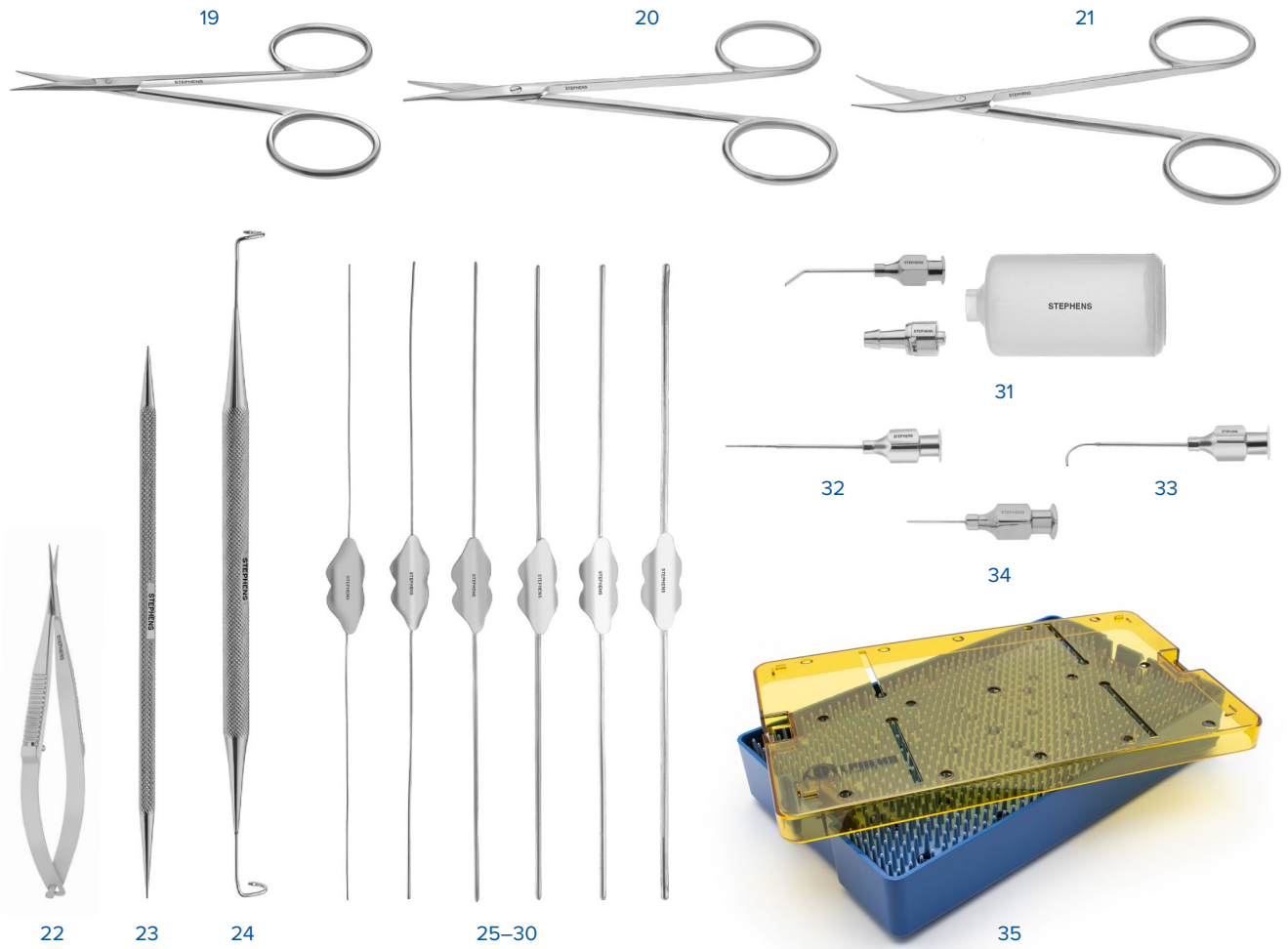

- 19 **S7-1035** Large Ring Scissors, Standard, Straight
- 20 **S7-1085** Stevens Tenotomy Scissors, Standard, Straight, Ring Handle
- 21 **S7-1090** Stevens Tenotomy Scissors, Standard, Curved, Ring Handle
- 22 **S7-1315** Westcott Tenotomy Stitch Scissors, Standard Blades, Extra Sharp Tips
- 23 **S8-1015** Castroviejo Lacrimal Dilator, Medium & Fine Points
- 24 **S8-1060** Pigtail Probe With Suture Holes
- 25 **S8-1065** Bowman Lacrimal Probe, Sterling Silver, 4/0-3/0
- 26 **S8-1070** Bowman Lacrimal Probe, Sterling Silver, 00-0
- 27 **S8-1075** Bowman Lacrimal Probe, Sterling Silver, 1-2
- 28 **S8-1080** Bowman Lacrimal Probe, Sterling Silver, 3-4
- 29 **S8-1085** Bowman Lacrimal Probe, Sterling Silver, 5-6
- 30 **S8-1090** Bowman Lacrimal Probe, Sterling Silver, 7-8
- 31 **SC-1005** Bishop-Harmon Anterior Chamber Irrigator, Complete Set
- 32 **SC-1530** Lacrimal Cannula, Reinforced, 23Ga Tip, Straight
- 33 **SC-1535** Lacrimal Cannula, Reinforced, 23Ga Tip, Curved
- 34 **SC-2005** Shahinian Cannula
- 35 **T2-0005** Plastic Instrument Tray, 6" x 10" x 1.5" (Double Level)

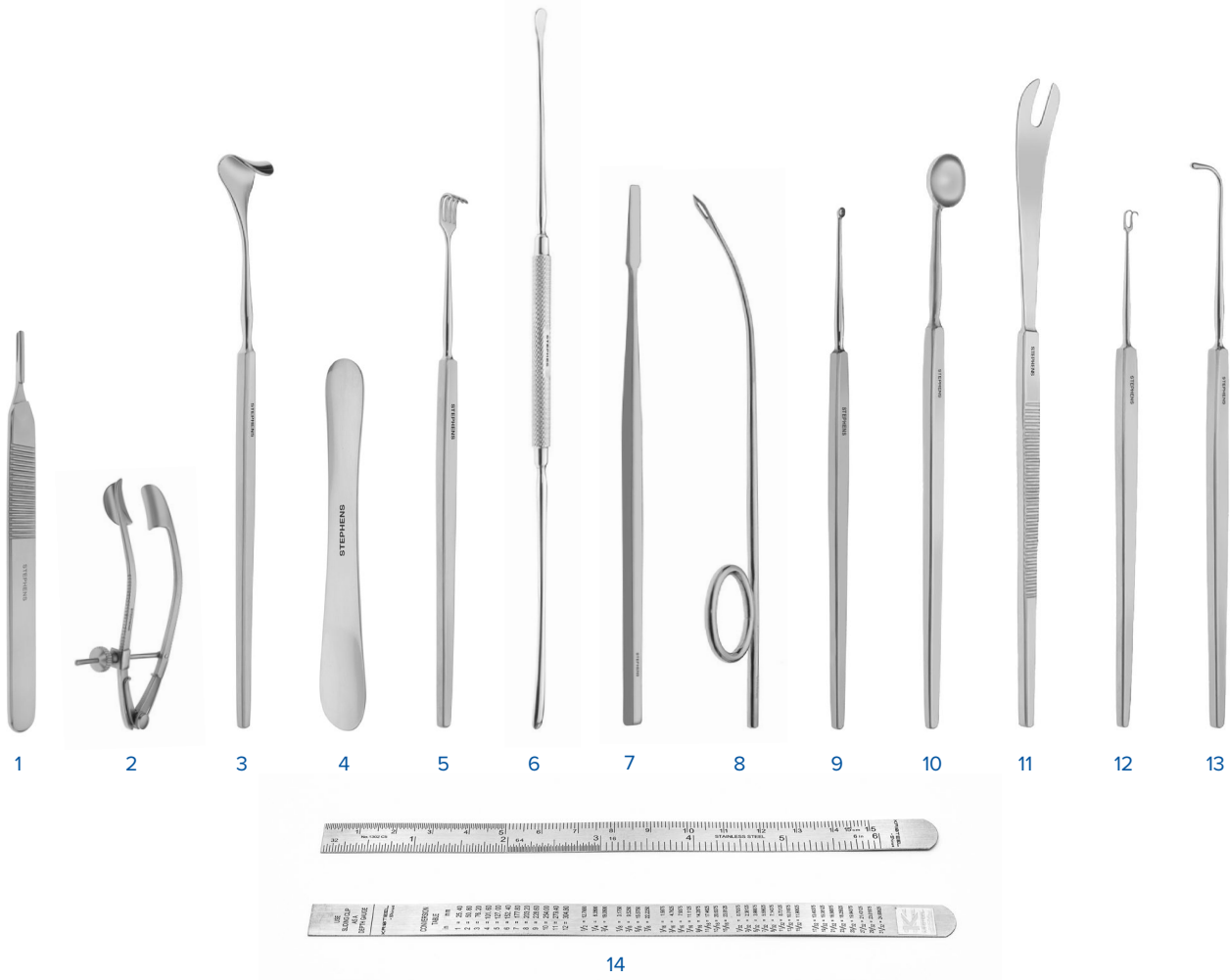

Oculoplastic

- | | | |
|----|----------------|--|
| 1 | AD-1000 | Blade Handle No. 3 |
| 2 | S1-1070 | Lancaster Speculum, Solid Blades |
| 3 | S1-1225 | Desmarres Lid Retractor #2, 15mm |
| 4 | S1-1235 | Jaeger Lid Plate |
| 5 | S1-1270 | Knapp Retractor, 4 Prongs, Blunt |
| 6 | S1-1275 | Tenzel Double Ended Periosteal Elevator |
| 7 | S1-1276 | West Lacrimal Chisel, Straight |
| 8 | S1-1310 | Wright Fascia Needle |
| 9 | S4-1015 | Meyerhoefer Chalazion Curette #3, 2.50mm |
| 10 | S4-1210 | Bunge Evisceration Spoon, Large |
| 11 | S4-1260 | Schepens Orbital Retractor |
| 12 | S4-1285 | Fixation Hook, Double Sharp, Large |
| 13 | S4-1415 | Graefe Muscle Hook, Medium #2 |
| 14 | S4-1490 | Ruler, Stainless Steel, 0.5mm Marking |

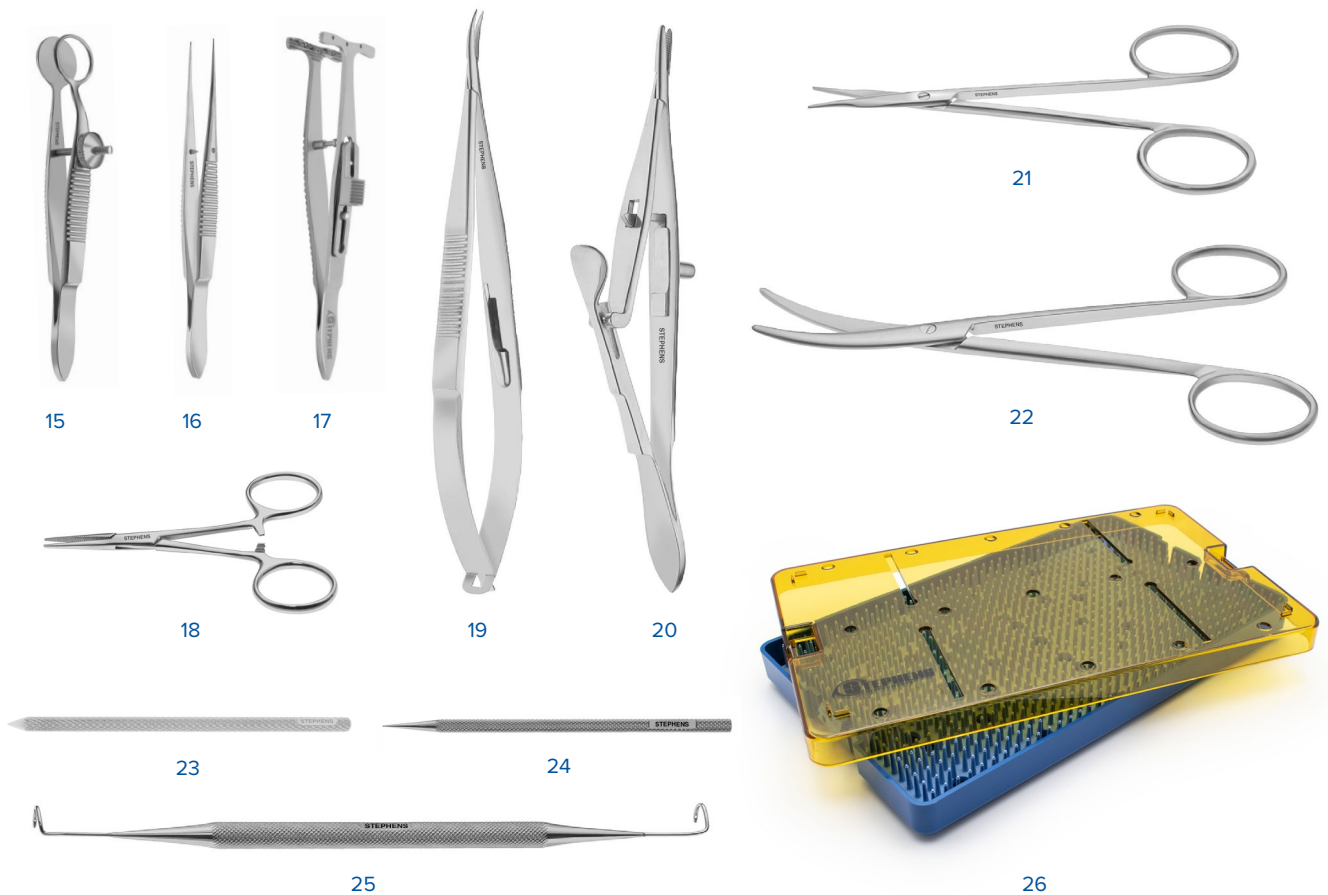

- 15 **S5-1045** Francis Chalazion Forceps, 12X14 Inside Diameter
- 16 **S5-1385** Tissue Forceps, 1X2 Teeth, Straight
- 17 **S5-1885** Putterman Muscle Conjunctival Clamp
- 18 **S5-1905** Mosquito Hemostat, 9Cm, Straight
- 19 **S6-1075** Castroviejo Needle Holder, Curved, With Lock, Delicate Jaws
- 20 **S6-1110** Kalt Needle Holder, Straight
- 21 **S7-1085** Stevens Tenotomy Scissors, Standard, Straight, Ring Handle
- 22 **S7-1130** Enucleation Scissors
- 23 **S8-1035M** Naugle-Fleming Knurled Dilator, 3.5mm Diameter
- 24 **S8-1040** Wilder Lacrimal Dilator, Medium Taper
- 25 **S8-1060** Pigtail Probe With Suture Holes
- 26 **T1-0005** Plastic Instrument Tray, 6" x 10" x 0.75"



Lid Surgery

- | | | |
|----|----------------|--|
| 1 | AD-1036 | Blade Handle, 3-Piece For Beaver |
| 2 | S1-1220 | Desmarres Lid Retractor #1, 13mm |
| 3 | S1-1225 | Desmarres Lid Retractor #2, 15mm |
| 4 | S1-1230 | Desmarres Lid Retractor #3, 17mm |
| 5 | S1-1270 | Knapp Retractor, 4 Prongs, Blunt |
| 6 | S4-1280 | Fixation Hook, Double Sharp, Small |
| 7 | S4-1415 | Graefe Muscle Hook, Medium #2 |
| 8 | S4-1455 | Castroviejo Caliper, Straight, 20mm |
| 9 | S5-1015 | Berke Ptosis Forceps, 20mm |
| 10 | S5-1058 | Stephens Meibomian Gland Expressor |
| 11 | S5-1370 | Bishop-Harmon Iris Forceps, 1X2 Teeth Fine, 0.3mm |
| 12 | S5-1570 | Castroviejo Suturing Forceps, 0.3mm, With Tying Platform |
| 13 | S5-1680 | Paton Tying Forceps, With Platform, Sharp Points |
| 14 | S5-1885 | Putterman Muscle Conjunctival Clamp |
| 15 | S5-1895 | Bonaccolto Utility & Splinter Forceps, Serrated |

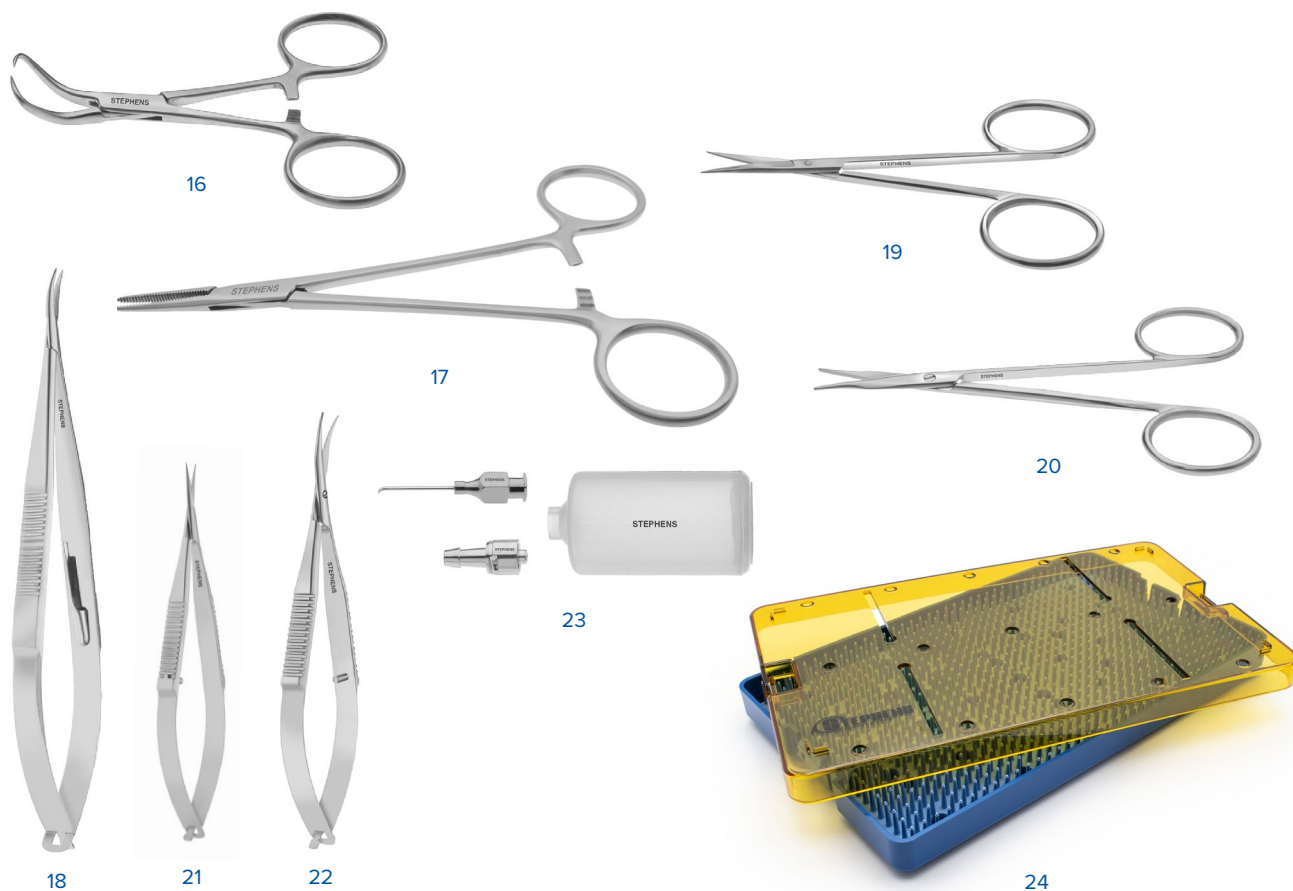

- 16 **S5-1904A** Backhaus Towel Clamp
- 17 **S5-1915** Mosquito Hemostat, 12.5Cm, Straight
- 18 **S6-1075** Castroviejo Needle Holder, Curved, With Lock, Delicate Jaws
- 19 **S7-1035** Large Ring Scissors, Standard, Straight
- 20 **S7-1085** Stevens Tenotomy Scissors, Standard, Straight, Ring Handle
- 21 **S7-1315** Westcott Tenotomy Stitch Scissors, Standard Blades, Extra Sharp Tips
- 22 **S7-1325** Westcott Tenotomy Scissors, Standard Blades, Blunt
- 23 **SC-1005** Bishop-Harmon Anterior Chamber Irrigator, Complete Set
- 24 **T1-0005** Plastic Instrument Tray, 6" x 10" x 0.75"

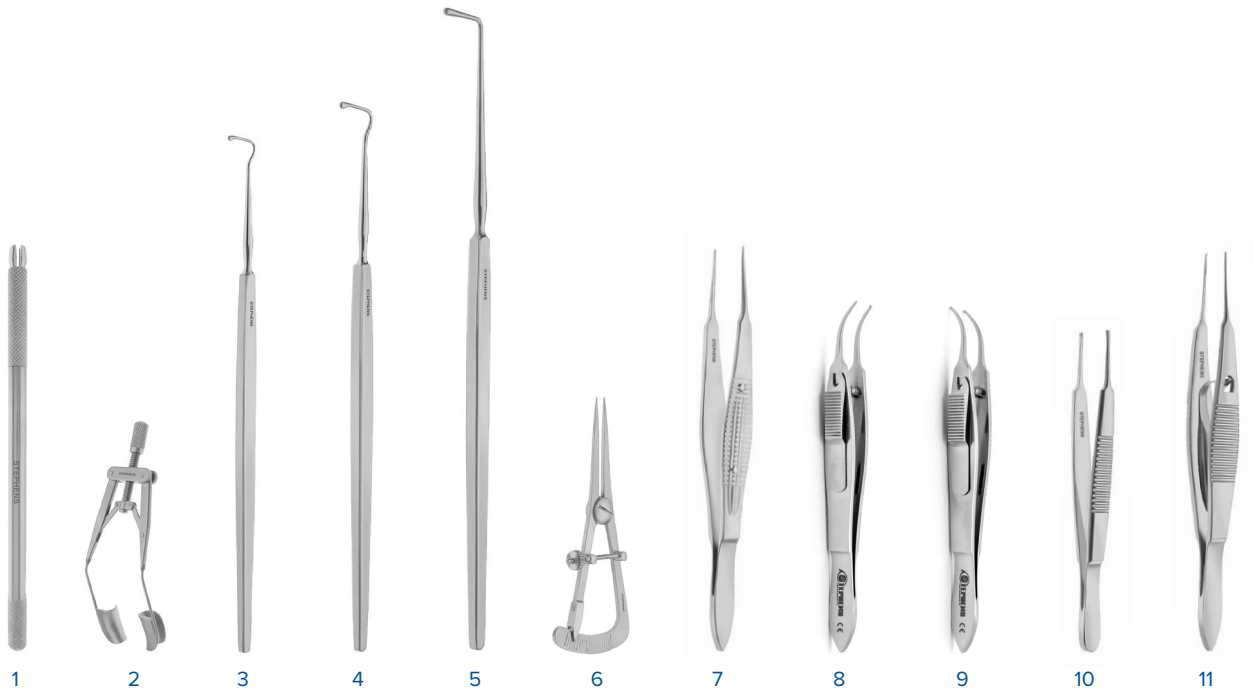

Strabismus

- | | | |
|----|----------------|--|
| 1 | AD-1036 | Blade Handle, 3-Piece For Beaver |
| 2 | S1-1028 | Lieberman Eye Speculum, Solid Blades |
| 3 | S4-1430 | Jameson Muscle Hook, Small |
| 4 | S4-1435 | Jameson Muscle Hook, Large |
| 5 | S4-1443 | Strabismus Hook, Extra Large |
| 6 | S4-1455 | Castroviejo Caliper, Straight, 20mm |
| 7 | S5-1240 | Bonn Forceps, 1X2 Teeth, 0.12mm, Long Model |
| 8 | S5-1410 | Moody Fixation Forceps, 0.5mm Teeth, Right |
| 9 | S5-1415 | Moody Fixation Forceps, 0.5mm Teeth, Left |
| 10 | S5-1440 | Lester Fixation Forceps, 9Cm, 2X3 Teeth, 0.6mm |

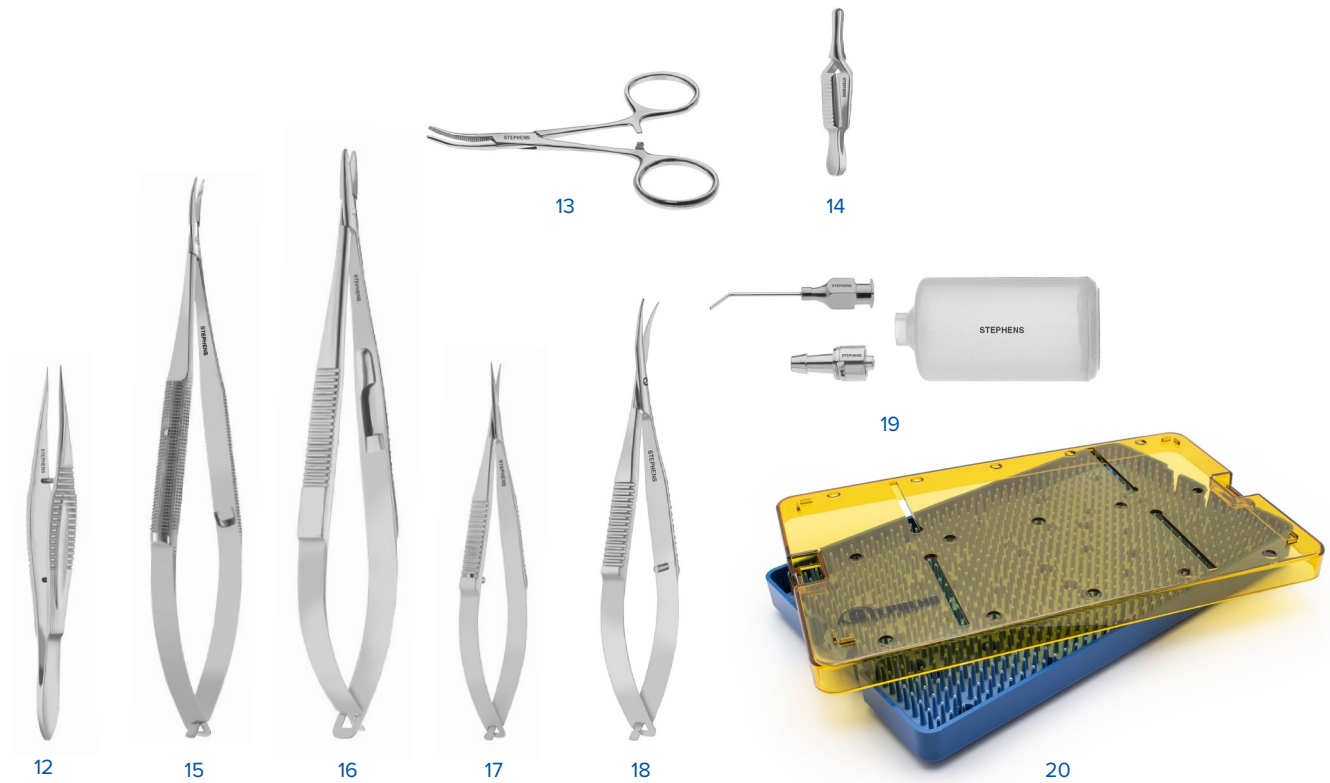

- 11 **S5-1576** Castroviejo Suturing Forceps, 0.5mm, With Tying Platform, With Lock
- 12 **S5-1680** Paton Tying Forceps, With Platform, Sharp Points
- 13 **S5-1910** Mosquito Hemostat, 9Cm, Curved
- 14 **S5-1925** Diffenbach Serrefine, 4Cm, Straight
- 15 **S6-1005** Barraquer Needle Holder, Curved, With Lock, Standard Jaws
- 16 **S6-1050** Castroviejo Needle Holder, Straight, With Lock, Standard Jaws
- 17 **S7-1315** Westcott Tenotomy Stitch Scissors, Standard Blades, Extra Sharp Tips
- 18 **S7-1325** Westcott Tenotomy Scissors, Standard Blades, Blunt
- 19 **SC-1005** Bishop-Harmon Anterior Chamber Irrigator, Complete Set
- 20 **T1-0005** Plastic Instrument Tray, 6" x 10" x 0.75"

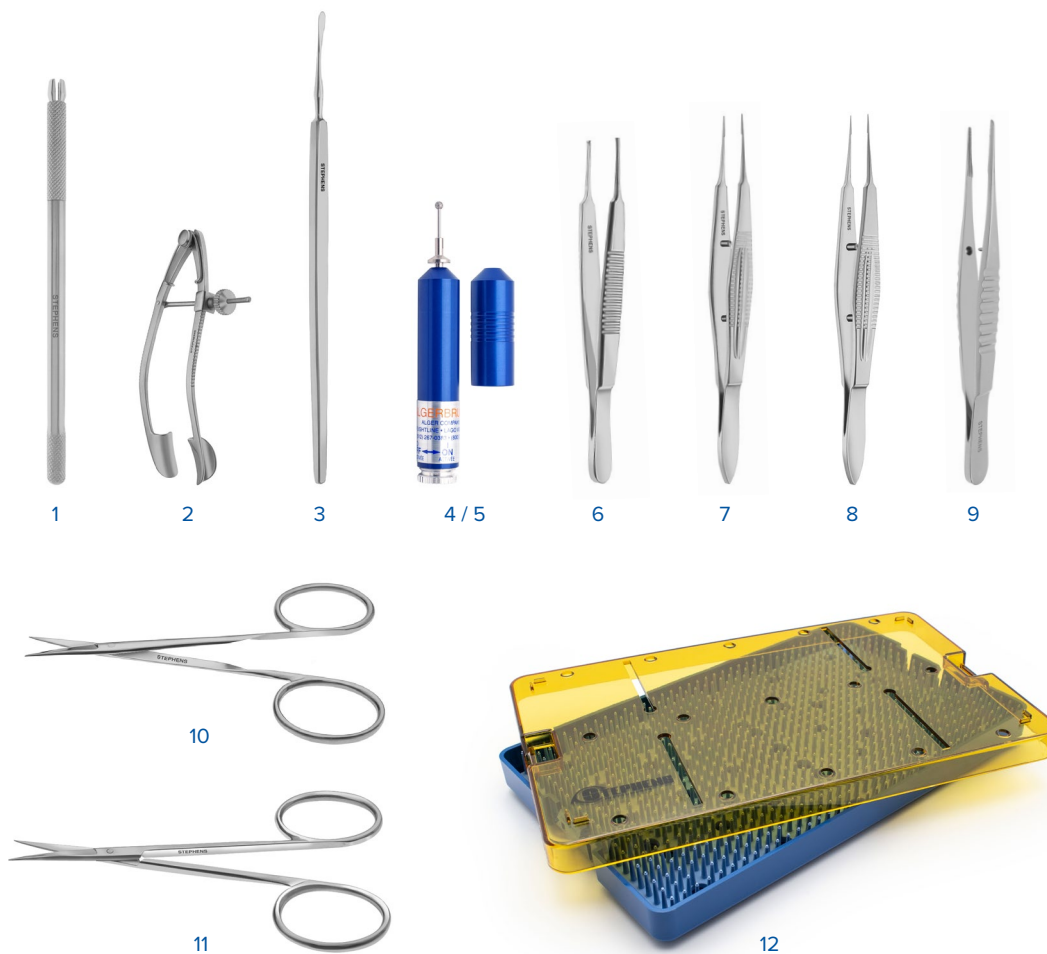

Pterygium Set

- | | | |
|----|----------------|---|
| 1 | AD-1036 | Blade Handle, 3-Piece For Beaver |
| 2 | S1-1070 | Barraquer Iris Spatula, Smooth, Round |
| 3 | S2-1115 | Gill Corneal Knife |
| 4 | S2-1176 | Pterygium Brush, 2.5mm Round Tip, Fine Grit, Diamond Dusted |
| 5 | S2-1179 | Chuck And Burr, For Pterygium Brush, 3.5mm Round Tip, Medium Grit, Diamond Dusted |
| 6 | S5-1440 | Lester Fixation Forceps, 9Cm, 2X3 Teeth, 0.6mm |
| 7 | S5-1560 | Castroviejo Suturing Forceps, 0.12mm, With Tying Platform |
| 8 | S5-1650 | Mcpherson Tying Forceps, Long Model, Straight, With Platform |
| 9 | S5-1960 | Bonaccolto Utility Forceps, Delicate Model |
| 10 | S7-1025 | Iris Scissors, Ribbon Type, Straight, Ring Handle |
| 11 | S7-1035 | Large Ring Scissors, Standard, Straight |
| 12 | T1-0005 | Plastic Instrument Tray, 6" x 10" x 0.75" |

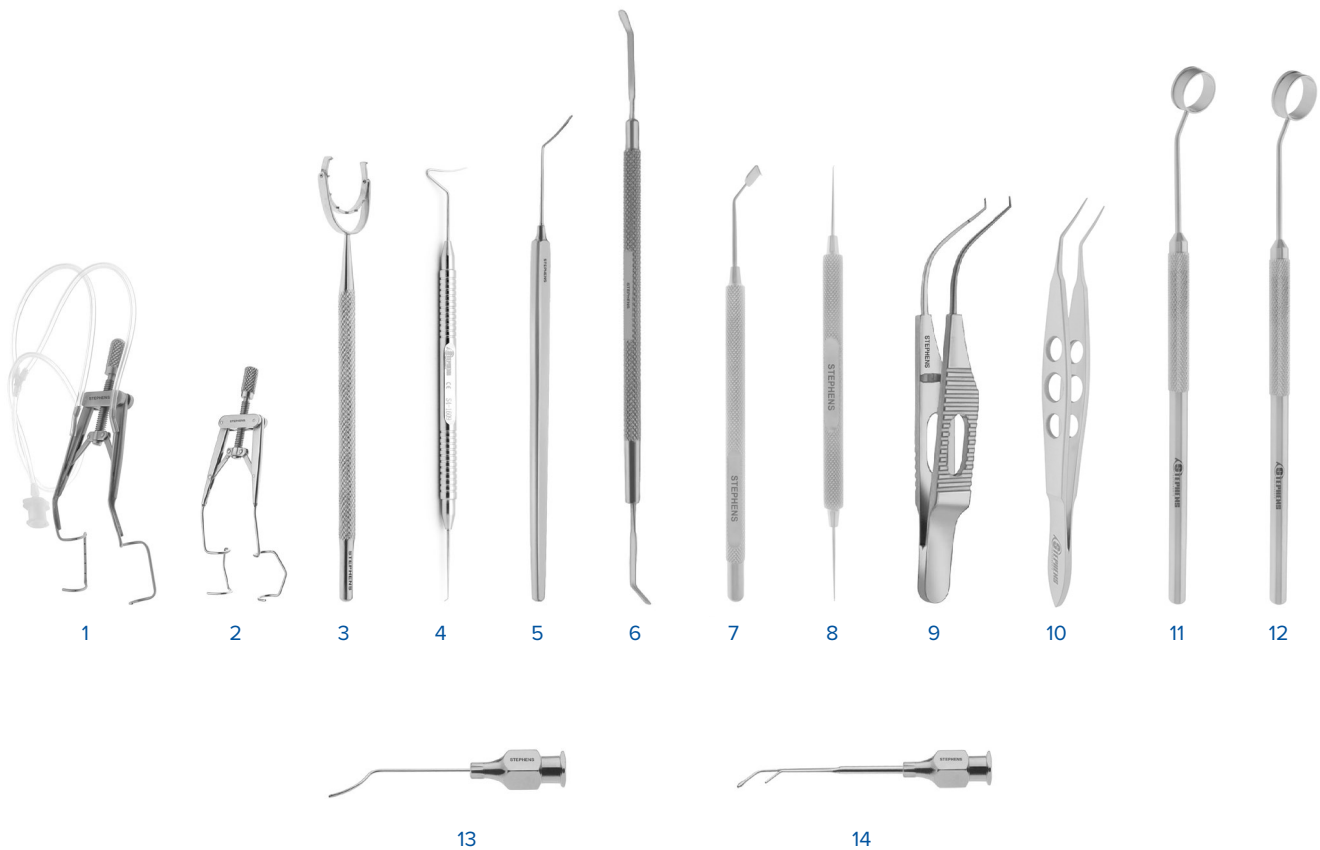

Lasik Set

- | | | |
|----|-----------------|--|
| 1 | S1-1025 | Stephens Irrigating Speculum |
| 2 | S1-1027 | Lieberman Adjustable Eye Speculum, V-Shaped Wire |
| 3 | S1-1211A | Thornton Fixation Ring, 12mm Swinging Handle, Open Ring 1/2 |
| 4 | S4-1609 | Seibel Intralase Separator/Elevator |
| 5 | S4-1615 | Slade Lasik Retreatment |
| 6 | S4-1620 | Herzing Lasik Elevator/Retractor |
| 7 | S4-1660 | Buratto Flap Protector |
| 8 | S4-1665 | Katzen Lasik Flap Unzipper |
| 9 | S5-1520 | Buratto Lasik Flap Forceps |
| 10 | S5-1525 | Mendez Lasik Flap Forceps |
| 11 | S9-1535 | Lasek Alcohol Well 8.5mm |
| 12 | S9-1536 | Lasek Alcohol Well 9.5mm |
| 13 | SC-5580 | Buratto Lasik Irrigation Cannula, 23Ga, 3 Irrigation Holes, Angled |
| 14 | SC-5596 | Gulani, Tri Functional Lasik |

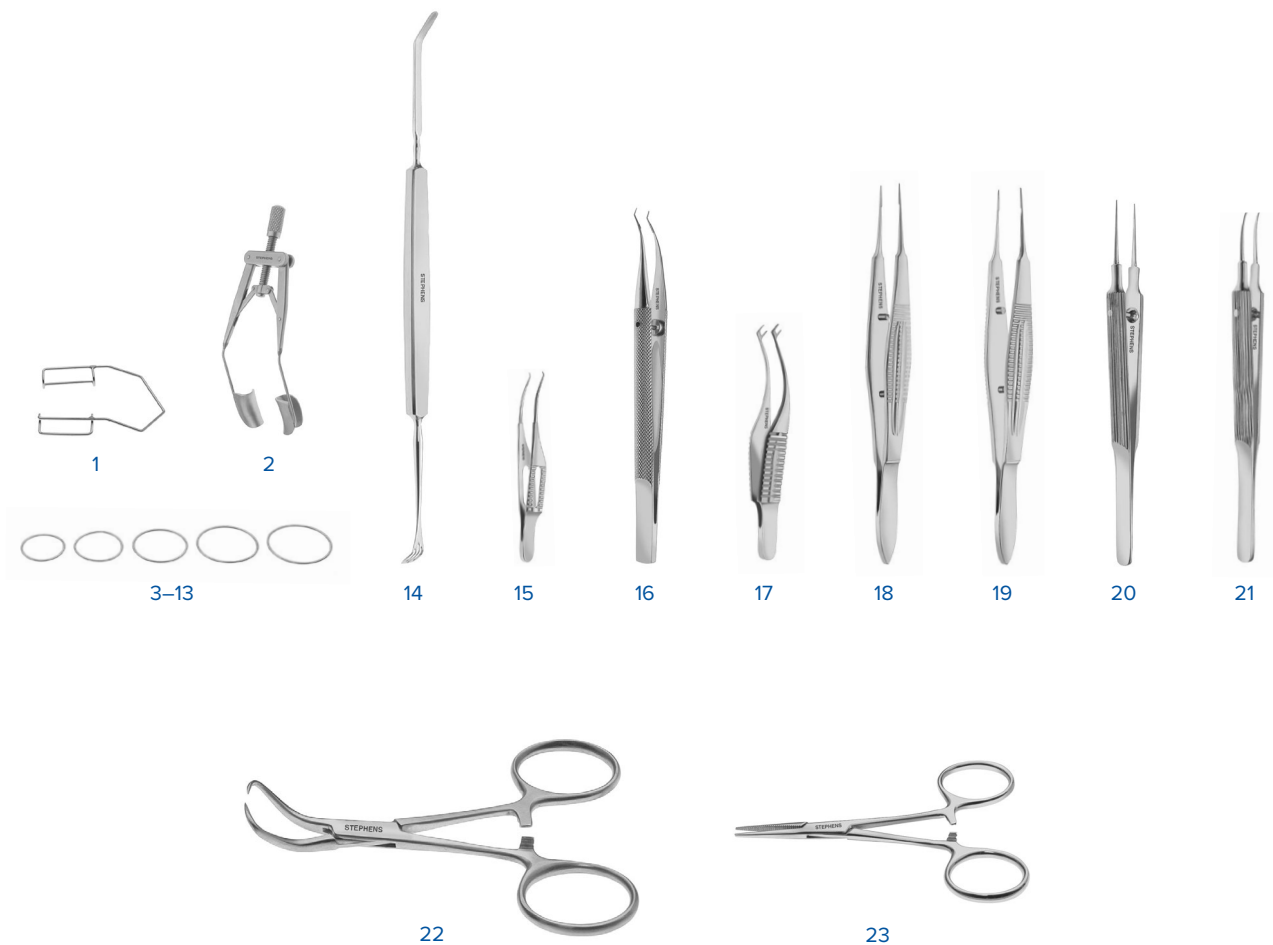

Corneal Transplant

- | | | |
|----|----------------|--|
| 1 | S1-1005 | Barraquer Wire Speculum, Adult, 15mm |
| 2 | S1-1028 | Lieberman Eye Speculum, Solid Blades |
| 3 | S1-1155 | Flieringa Fixation Ring, 12mm |
| 4 | S1-1160 | Flieringa Fixation Ring, 13mm |
| 5 | S1-1165 | Flieringa Fixation Ring, 14mm |
| 6 | S1-1170 | Flieringa Fixation Ring, 15mm |
| 7 | S1-1175 | Flieringa Fixation Ring, 16mm |
| 8 | S1-1180 | Flieringa Fixation Ring, 17mm |
| 9 | S1-1185 | Flieringa Fixation Ring, 18mm |
| 10 | S1-1190 | Flieringa Fixation Ring, 19mm |
| 11 | S1-1195 | Flieringa Fixation Ring, 20mm |
| 12 | S1-1200 | Flieringa Fixation Ring, 21mm |
| 13 | S1-1205 | Flieringa Fixation Ring, 22mm |
| 14 | S4-1154 | Paton Double Spatula, Angled, 2mm Tip |
| 15 | S5-1120 | Barraquer Colibri Forceps, 0.12mm With Tying Platform |
| 16 | S5-1140 | Colibri Forceps, 0.12mm, Round Handle |
| 17 | S5-1443 | Hoffer-Mcpherson Corneal Bi-Fixation Forceps, 0.12mm Teeth, 2 Sets Of 1X2, On A Gills Handle |
| 18 | S5-1560 | Castroviejo Suturing Forceps, 0.12mm, With Tying Platform |

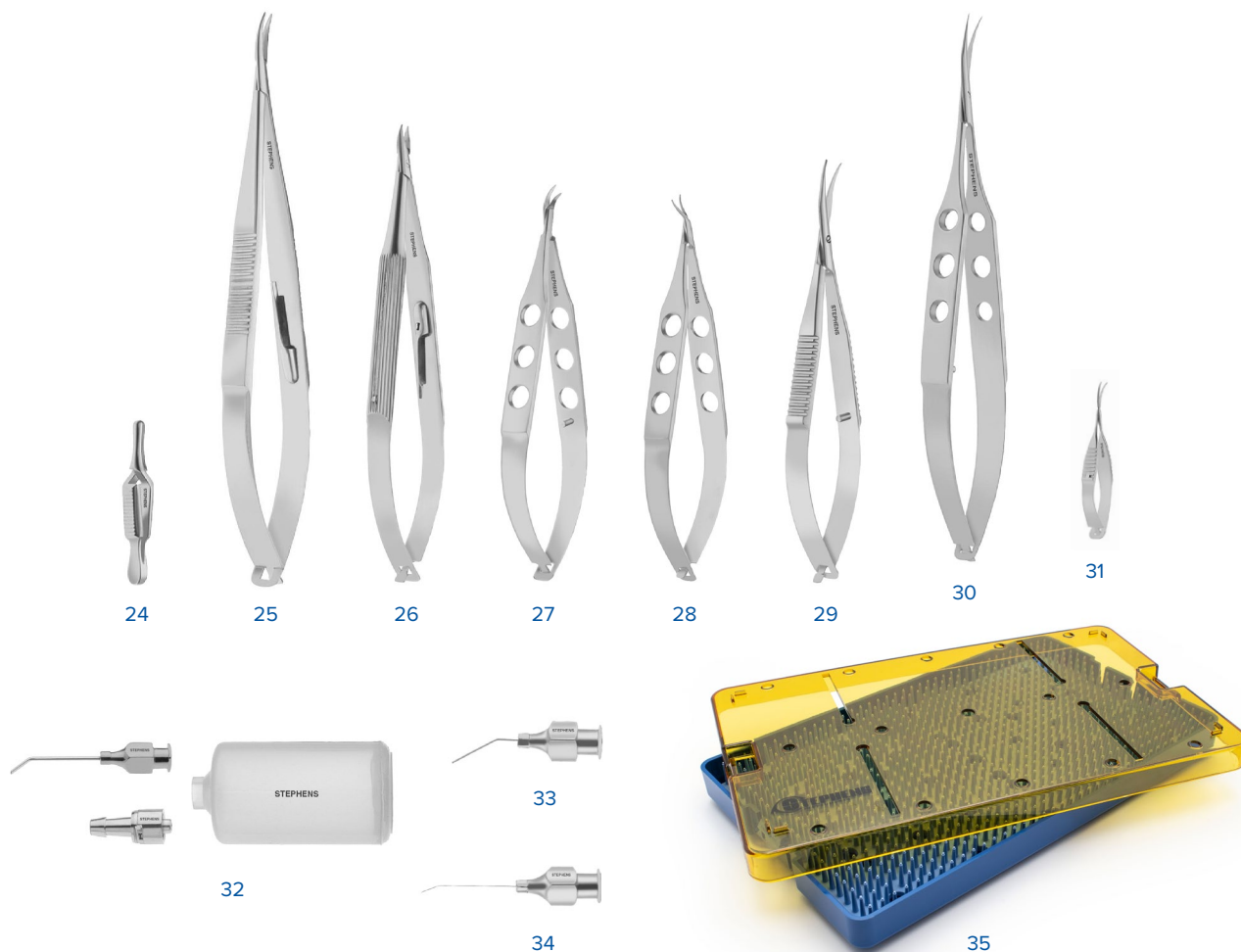

- 19 **S5-1570** Castroviejo Suturing Forceps, 0.3mm, With Tying Platform
- 20 **S5-1670** Tennant Tying Forceps, Round Hand, Straight, With Platform
- 21 **S5-1675** Tennant Tying Forceps, Round Hand, Curved, With Platform
- 22 **S5-1904A** Backhaus Towel Clamp
- 23 **S5-1905** Mosquito Hemostat, 9Cm, Straight
- 24 **S5-1925** Diffenbach Serrefine, 4Cm, Straight
- 25 **S6-1075** Castroviejo Needle Holder, Curved, With Lock, Delicate Jaws
- 26 **S6-1130** Stephens Needle Holder, Curved, With Lock, Very Delicate Jaws
- 27 **S7-1165** Castroviejo Corneal Section Scissors, Small, Right
- 28 **S7-1170** Castroviejo Corneal Section Scissors, Small, Left
- 29 **S7-1325** Westcott Tenotomy Scissors, Standard Blades, Blunt
- 30 **S7-1335** Jaffe Stitch Scissors, Extra Delicate, Very Sharp, Long
- 31 **S7-1389** Cohan-Vannas Scissors
- 32 **SC-1005** Bishop-Harmon Anterior Chamber Irrigator, Complete Set
- 33 **SC-1130** Anterior Chamber Cannula, 26Ga, Angled
- 34 **SC-1625** Air Injection Cannula, Smooth Angled Tip, 30Ga
- 35 **T1-0005** Plastic Instrument Tray, 6" x 10" x 0.75"

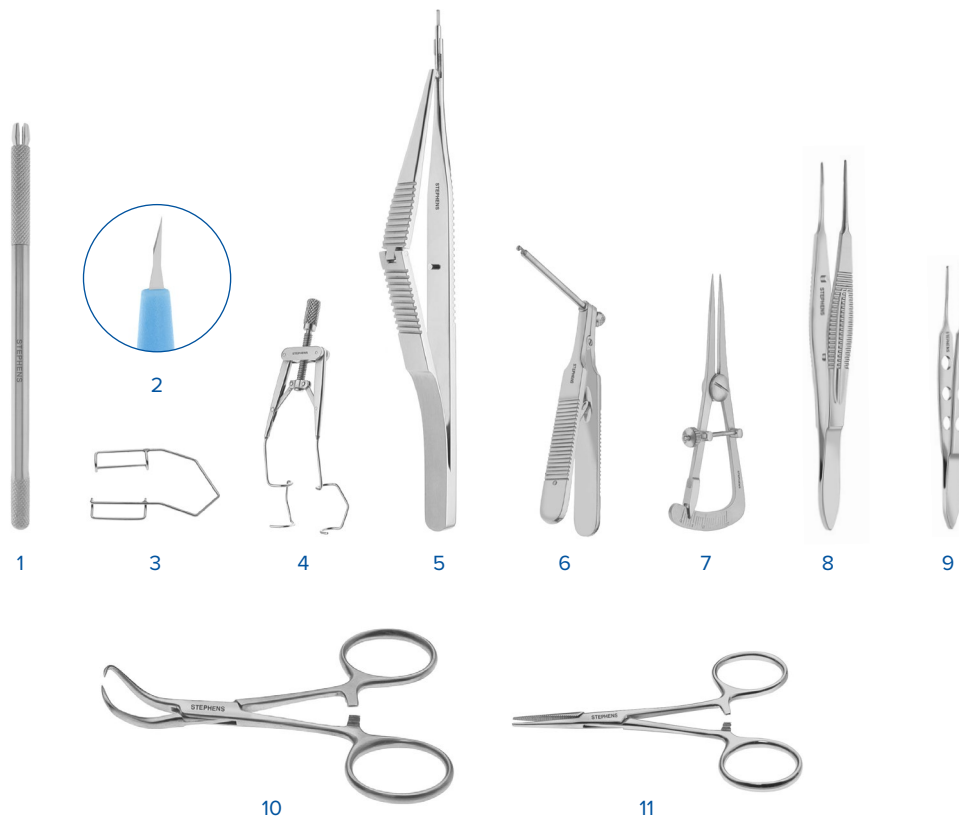

Glaucoma

- | | | |
|----|-----------------|--|
| 1 | AD-1036 | Blade Handle, 3-Piece For Beaver |
| 2 | R-1500 | 15 Degree Stab Knife |
| 3 | S1-1005 | Barraquer Wire Speculum, Adult, 15mm |
| 4 | S1-1027 | Lieberman Adjustable Eye Speculum, V-Shaped Wire |
| 5 | S3-1036 | Kelly Descemet Membrane Punch, 1.0mm |
| 6 | S3-1037 | Reiss Corneoscleral Punch, Rotating Tip |
| 7 | S4-1455 | Castroviejo Caliper, Straight, 20mm |
| 8 | S5-1355 | Macgregor Conjunctiva Forceps, 6mm Tying Platform, Serrated Tips |
| 9 | S5-1365 | Bishop-Harmon Iris Forceps, 1X2 Teeth Standard, 0.8mm |
| 10 | S5-1904A | Backhaus Towel Clamp |
| 11 | S5-1905 | Mosquito Hemostat, 9Cm, Straight |

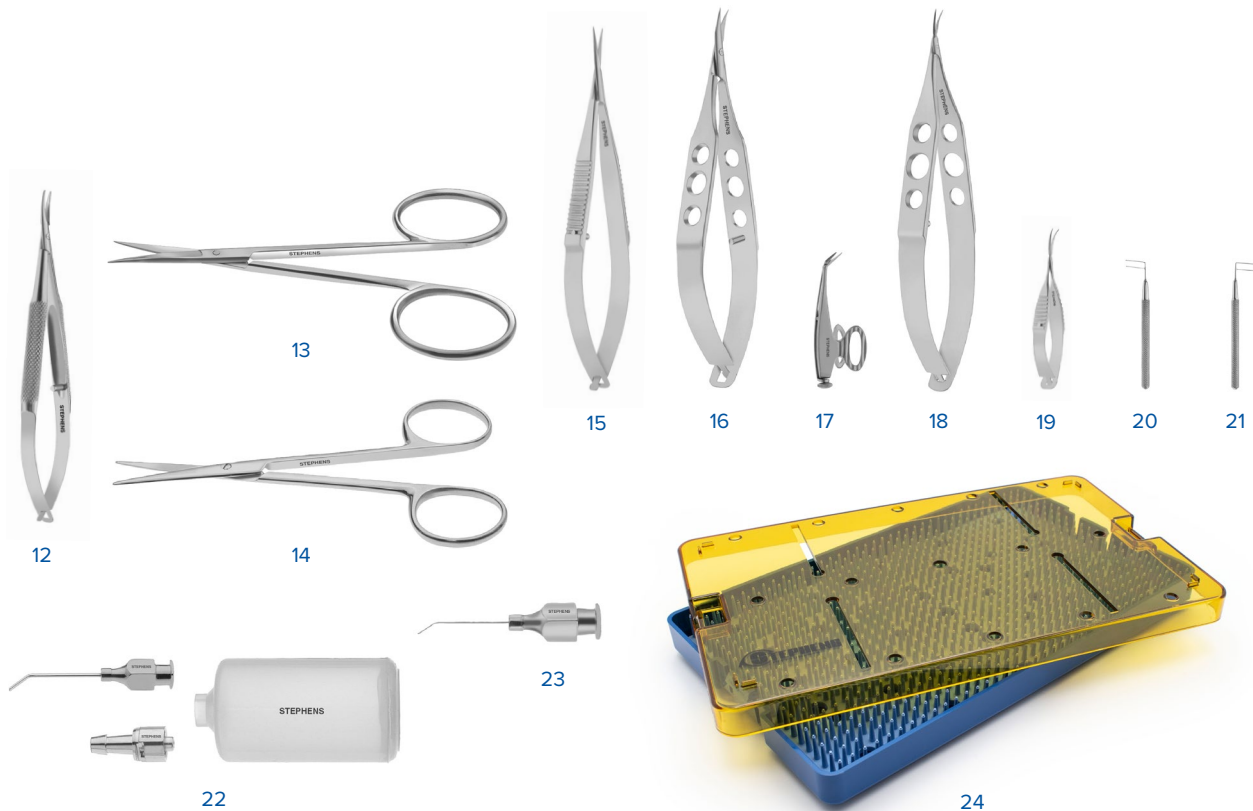

- 12 **S6-1040** Barraquer Short Needle Holder, Curved, Without Lock, Delicate Jaw
- 13 **S7-1035** Large Ring Scissors, Standard, Straight
- 14 **S7-1120** Knapp Strabismus Scissors, Ribbon, Straight, Ring Handle
- 15 **S7-1315** Westcott Tenotomy Stitch Scissors, Standard Blades, Extra Sharp Tips
- 16 **S7-1330** Mcpherson-Westcott Stitch Scissors, Small Blades, Extra Sharp
- 17 **S7-1360** Barraquer Iris Scissors, 7mm Blades
- 18 **S7-1367** Stephens-Vannas Scissors, 7mm Thin Blades, Curved
- 19 **S7-1389** Cohan-Vannas Scissors
- 20 **S8-1000** Harms Trabeculotomy Probe, Right
- 21 **S8-1005** Harms Trabeculotomy Probe, Left
- 22 **SC-1005** Bishop-Harmon Anterior Chamber Irrigator, Complete Set
- 23 **SC-1630** Air Injection Cannula, Smooth Angled Tip, 27Ga
- 24 **T1-0005** Plastic Instrument Tray, 6" x 10" x 0.75"

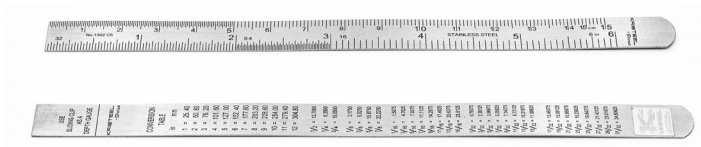
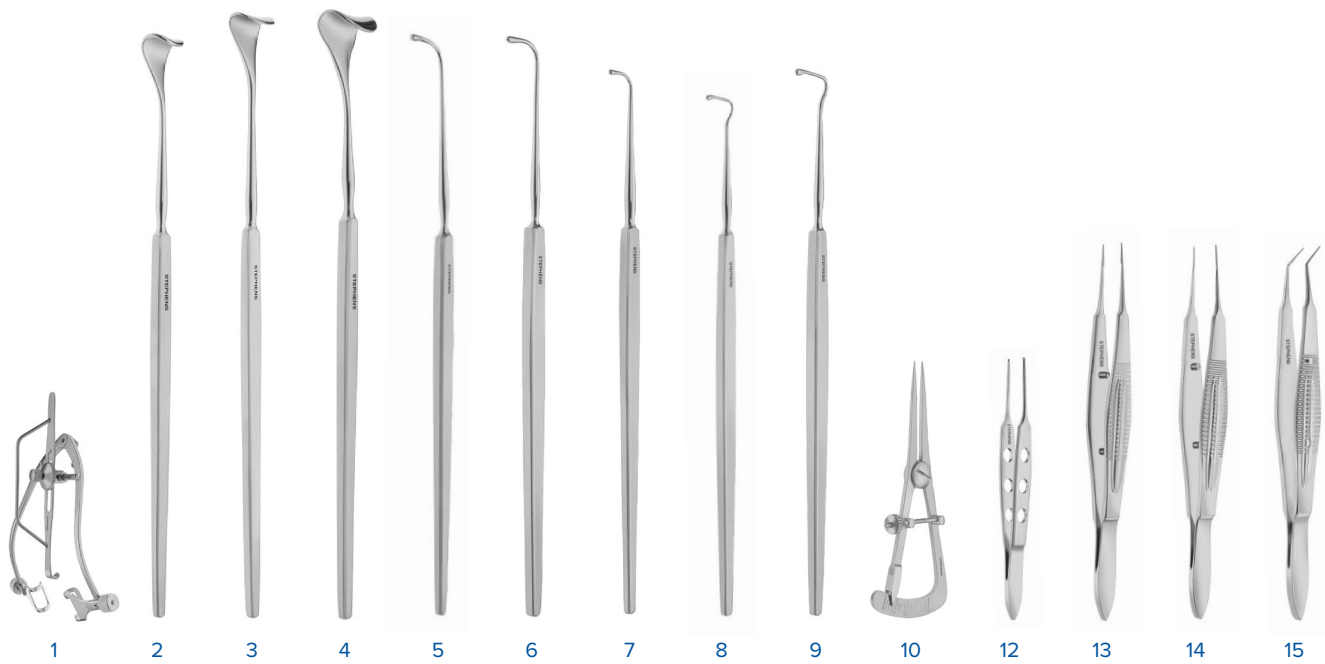

11

Muscle Set

- 1 **S1-1120** Maumenee-Park Speculum, Fenestrated Blades
- 2 **S1-1215** Lieberman Eye Speculum, Solid Blades
- 3 **S1-1220** Desmarres Lid Retractor #1, 13mm
- 4 **S1-1225** Desmarres Lid Retractor #2, 15mm
- 5 **S4-1410** Graefe Muscle Hook, Large #3
- 6 **S4-1415** Graefe Muscle Hook, Medium #2
- 7 **S4-1420** Graefe Muscle Hook, Small #1
- 8 **S4-1430** Jameson Muscle Hook, Small
- 9 **S4-1435** Jameson Muscle Hook, Large
- 10 **S4-1455** Castroviejo Caliper, Straight, 20mm
- 11 **S4-1490** Ruler, Stainless Steel, 0.5mm Marking
- 12 **S5-1365** Bishop-Harmon Iris Forceps, 1X2 Teeth Standard, 0.8mm
- 13 **S5-1560** Castroviejo Suturing Forceps, 0.12mm, With Tying Platform
- 14 **S5-1570** Castroviejo Suturing Forceps, 0.3mm, With Tying Platform
- 15 **S5-1630** Kelman-Mcpherson Tying Forceps, 8mm, Angled

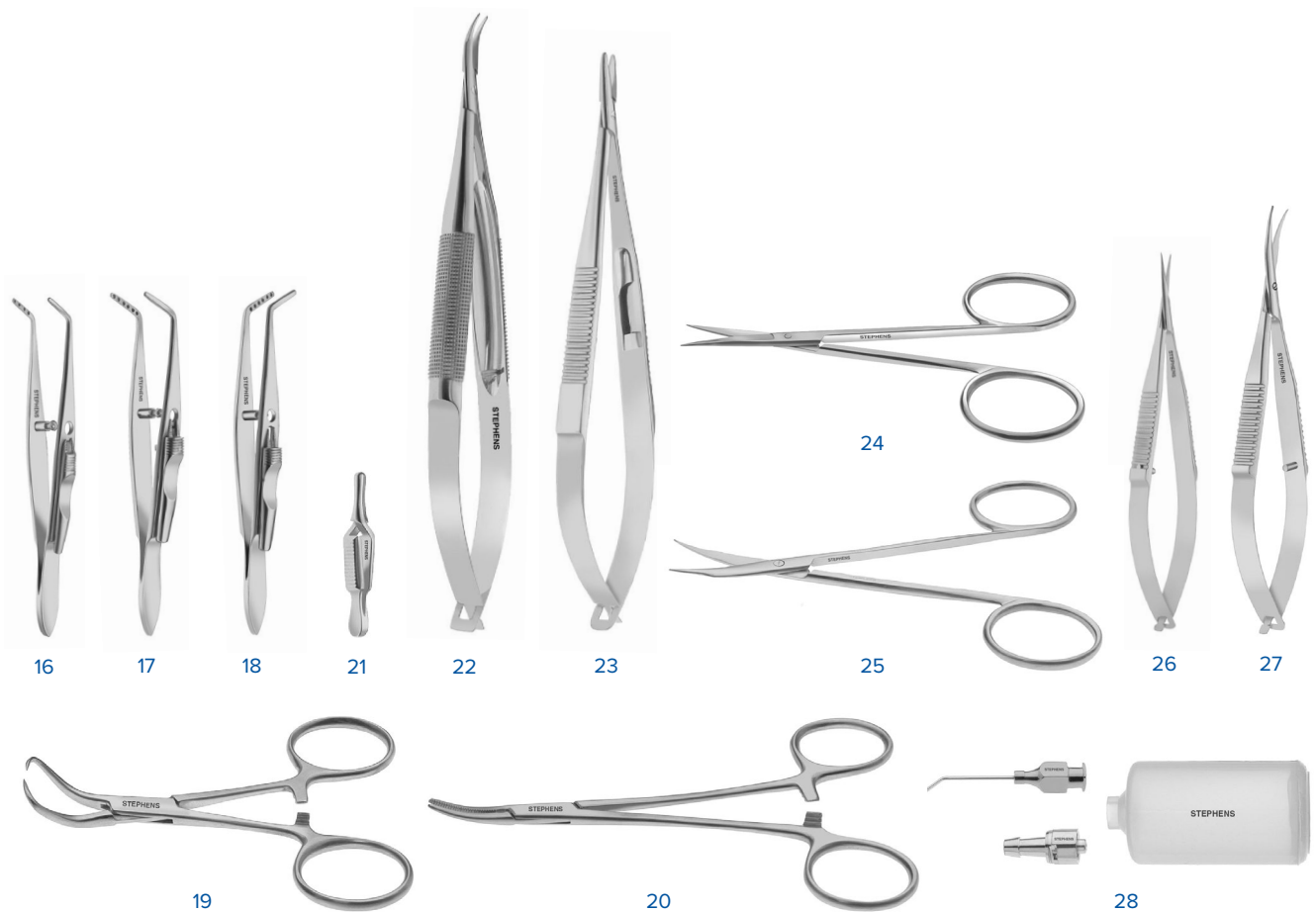

- 16 **S5-1850** Jameson Muscle Forceps, With Lock, Child, Left
- 17 **S5-1860** Jameson Muscle Forceps, With Lock, Adult, Left
- 18 **S5-1865** Jameson Muscle Forceps, With Lock, Adult, Right
- 19 **S5-1904A** Backhaus Towel Clamp
- 20 **S5-1920** Mosquito Hemostat, 12.5Cm, Curved
- 21 **S5-1925** Diffenbach Serrefine, 4Cm, Straight
- 22 **S6-1010** Barraquer Needle Holder, Curved, Without Lock, 0.5mm
- 23 **S6-1050** Castroviejo Needle Holder, Straight, With Lock, Standard Jaws
- 24 **S7-1035** Large Ring Scissors, Standard, Straight
- 25 **S7-1090** Stevens Tenotomy Scissors, Standard, Curved, Ring Handle
- 26 **S7-1315** Westcott Tenotomy Stitch Scissors, Standard Blades, Extra Sharp Tips
- 27 **S7-1325** Westcott Tenotomy Scissors, Standard Blades, Blunt
- 28 **SC-1005** Bishop-Harmon Anterior Chamber Irrigator, Complete Set

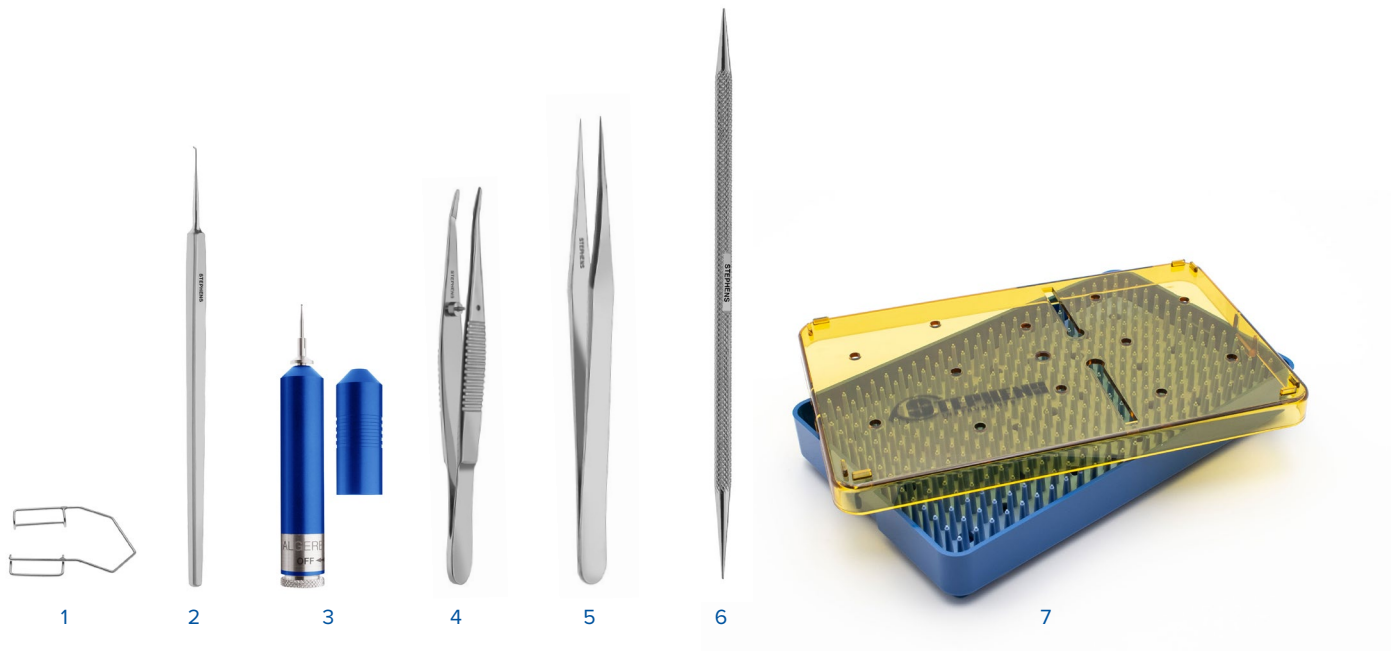

Foreign Body

- | | | |
|---|----------------|--|
| 1 | S1-1005 | Barraquer Wire Speculum, Adult, 15mm |
| 2 | S2-1135 | Golf Club Foreign Body Spud |
| 3 | S2-1170 | Alger Brush, Rust Ring Remover |
| 4 | S5-1085 | Barraquer Cilia Forceps |
| 5 | S5-1690 | Jewelers Forceps, #1, Straight |
| 6 | S8-1015 | Castroviejo Lacrimal Dilator, Medium & Fine Points |
| 7 | T1-0003 | Plastic Instrument Tray, 4" x 6.5" x 0.75" |

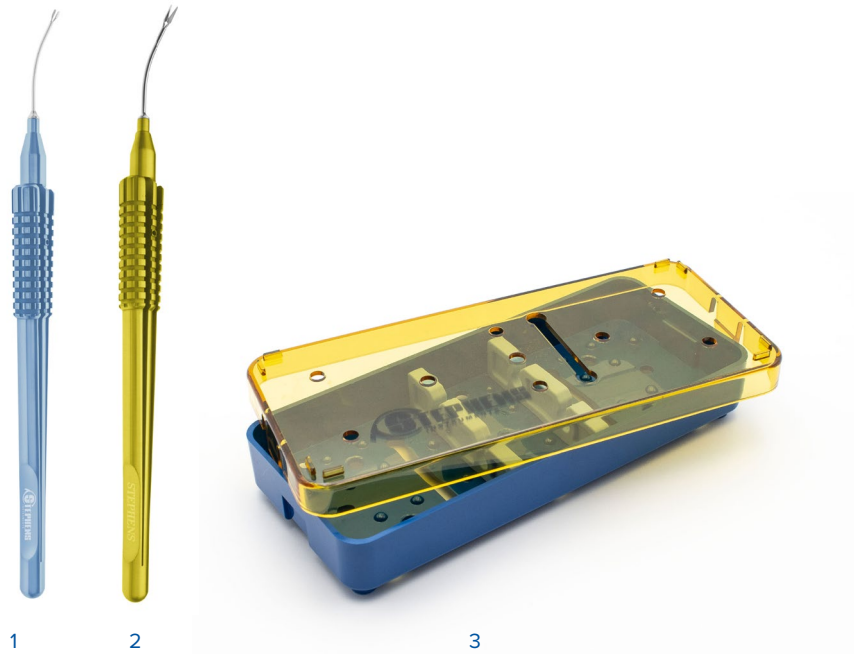

IOL Removal

- 1 **ST5-7070** Titanium Iol Holding Forceps, Grooved Jaws, 20Ga
- 2 **ST7-1410** Titanium Iol Cutting Scissors, 18Ga
- 3 **T1-0007** Plastic Instrument Tray, 2.5" x 6" x 0.75" (Silicone Bars)

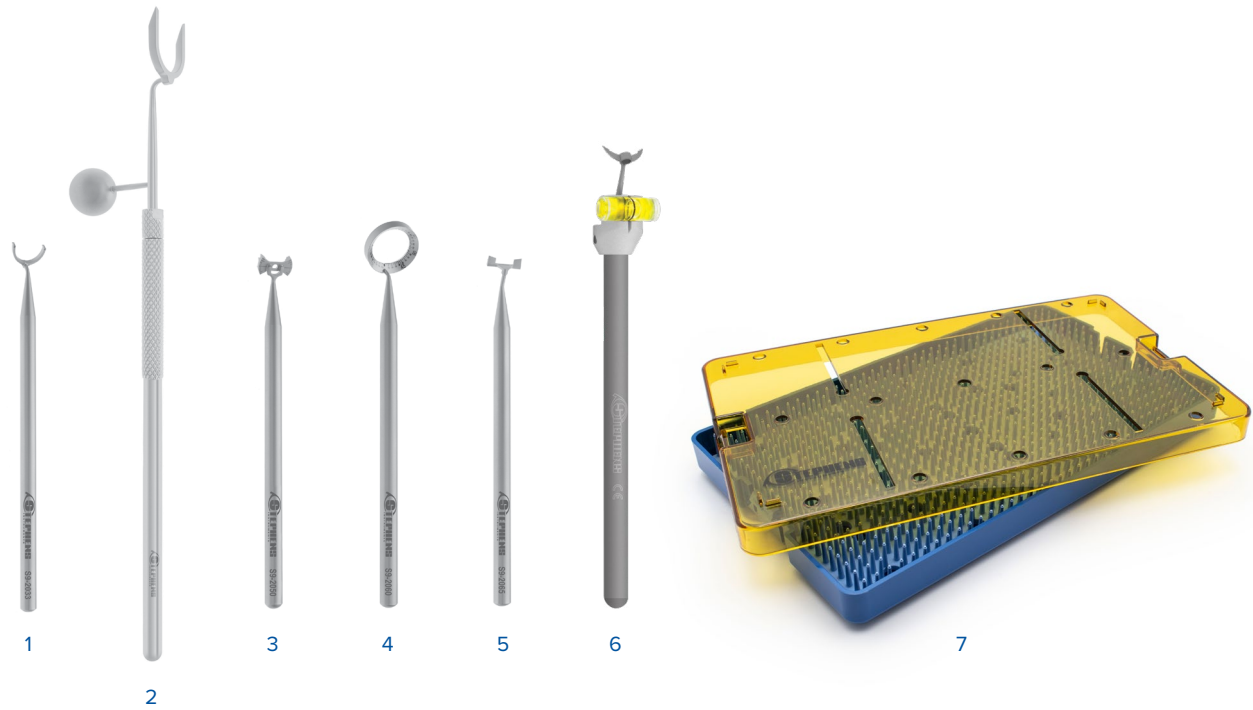

Toric IOL

- | | | |
|---|----------------|--|
| 1 | S9-2033 | Henderson Pre Operative Alignment Marker |
| 2 | S9-2040 | Lri Gravity Marker, 12.5mm At 3 & 9 |
| 3 | S9-2050 | Henderson 30, 45, 60 Degree Lri Axis Marker |
| 4 | S9-2060 | Henderson Degree Gauge |
| 5 | S9-2065 | Henderson Toric Iol Marker |
| 6 | S9-2070 | Stephens Toric Iol Marker, With Bubble Level |
| 7 | T1-0005 | Plastic Instrument Tray, 6" x 10" x 0.75" |

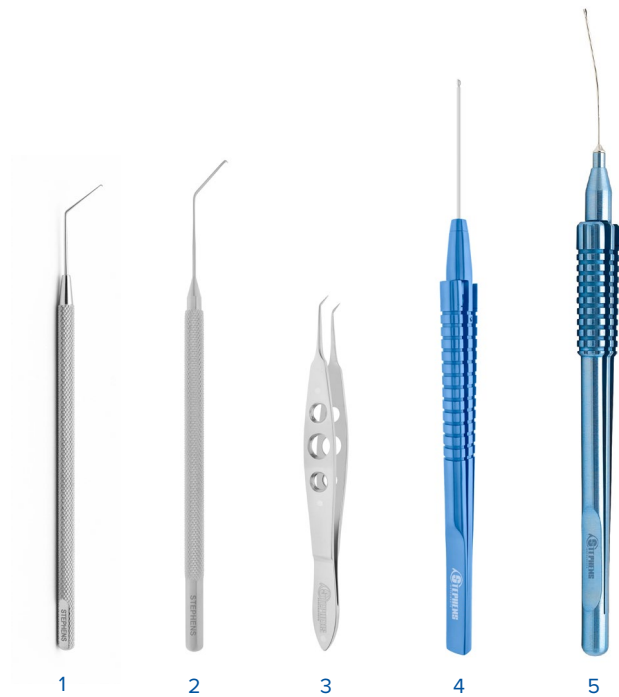

DSEK / DMEK

- | | | |
|---|-----------------|--|
| 1 | S4-1397 | Reverse Sinskey Hook For Dsek |
| 2 | S4-1670 | Endothelial Stripper |
| 3 | S5-1655M | Dmek Tissue Prep Forceps, 2.5mm Platform |
| 4 | ST5-7056 | Titanium Asymmetrical Forceps, 25Ga |
| 5 | ST5-7060 | Titanium Dsaek Corneal Forceps, 23Ga |



LACRIVERA®

A Stephens Instruments Company

Dry Eye Management

Silicone Plugs	188
Temporary Plugs	194
Ancillaries	198

VeraPlug™
FlexFit™
Punctal Occlusion System



The VeraPlug™ FlexFit™ is designed for **simple sizing, easy insertion, patient comfort, and retention**—providing a proven treatment for chronic dry eye.

- Two sizes fit most patients for **simple sizing**
- FlexFit™ nose design provides **easy insertion** and **superior retention**
- Low-profile dome for excellent **patient comfort**



VeraPlug FlexFit Sterile Preloaded

Individually packaged and preloaded on a sterile, disposable inserter. 1 pair per box.

SKU		SIZE
VFF-5000	VeraPlug FlexFit Sterile Preloaded - X-Small	0.2mm to 0.3mm
VFF-5001	VeraPlug FlexFit Sterile Preloaded - Small	0.3mm to 0.5mm
VFF-5002	VeraPlug FlexFit Sterile Preloaded - Medium	0.6mm to 0.8mm
VFF-5003	VeraPlug FlexFit Sterile Preloaded - Large	0.9mm to 1.0mm

VeraPlug FlexFit Bulk Nonsterile

Packaged nonsterile, 1 pair per poly bag. 10 pairs per box. Inserters included.

SKU		SIZE
BFF-5000	VeraPlug FlexFit Nonsterile Bulk - X-Small	0.2mm to 0.3mm
BFF-5001	VeraPlug FlexFit Nonsterile Bulk - Small	0.3mm to 0.5mm
BFF-5002	VeraPlug FlexFit Nonsterile Bulk - Medium	0.6mm to 0.8mm
BFF-5003	VeraPlug FlexFit Nonsterile Bulk - Large	0.9mm to 1.0mm

VeraPlug™

Punctal Occlusion System

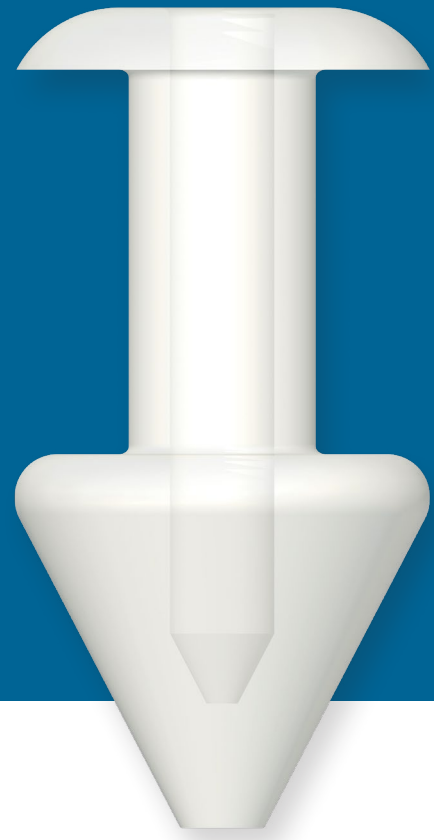

The **VeraPlug™** is designed to provide a simple and effective treatment for chronic dry eye.

- Engineered to perfectly fit the puncta for **excellent retention**
- Low-profile dome for **enhanced patient comfort**
- Proprietary shaft design for **easy insertion** and **proper anatomic fit**
- Available in four sizes



VeraPlug Sterile Preloaded

Individually packaged and preloaded on a sterile, disposable inserter. 1 pair per box.

SKU		SIZE
VSP-1001	VeraPlug Sterile Preloaded - Small	0.4mm to 0.6mm
VSP-1002	VeraPlug Sterile Preloaded - Medium	0.6mm to 0.7mm
VSP-1003	VeraPlug Sterile Preloaded - Large	0.7mm to 0.8mm
VSP-1004	VeraPlug Sterile Preloaded - X-Large	0.8mm to 1.0mm

VeraPlug Bulk Nonsterile

Packaged nonsterile, 1 pair per poly bag, 10 pairs per box. Inserters included.

SKU		SIZE
BNS-1001	VeraPlug Nonsterile Bulk - Small	0.4mm to 0.6mm
BNS-1002	VeraPlug Nonsterile Bulk - Medium	0.6mm to 0.7mm
BNS-1003	VeraPlug Nonsterile Bulk - Large	0.7mm to 0.8mm
BNS-1004	VeraPlug Nonsterile Bulk - X-Large	0.8mm to 1.0mm

VeraPlug™ *flow*

Punctal Occlusion System

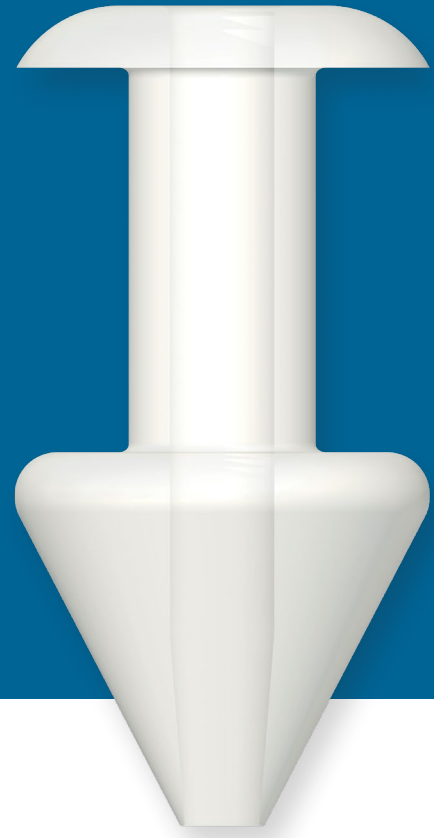

The **VeraPlug™ Flow** is designed to provide a simple and effective means of slowing tear drainage.

- Inner channel reduces but does not eliminate tear flow, providing only **partial occlusion**
- Engineered to perfectly fit the puncta for **excellent retention**
- Low-profile dome for **enhanced patient comfort**
- Proprietary shaft design for **easy insertion** and **proper anatomic fit**



VeraPlug Flow Sterile Preloaded

Individually packaged and preloaded on a sterile, disposable inserter. 1 pair per box.

SKU		SIZE
VFL-1001	VeraPlug Flow Sterile Preloaded - Small	0.4mm to 0.6mm
VFL-1002	VeraPlug Flow Sterile Preloaded - Medium	0.6mm to 0.7mm
VFL-1003	VeraPlug Flow Sterile Preloaded - Large	0.7mm to 0.8mm
VFL-1004	VeraPlug Flow Sterile Preloaded - X-Large	0.8mm to 1.0mm

VeraPlug Flow Bulk Nonsterile

Packaged nonsterile, 1 pair per poly bag. 5 pairs per box. Inserters included.

SKU		SIZE
BVF-1001	VeraPlug Flow Nonsterile Bulk - Small	0.4mm to 0.6mm
BVF-1002	VeraPlug Flow Nonsterile Bulk - Medium	0.6mm to 0.7mm
BVF-1003	VeraPlug Flow Nonsterile Bulk - Large	0.7mm to 0.8mm
BVF-1004	VeraPlug Flow Nonsterile Bulk - X-Large	0.8mm to 1.0mm

Vera180™

Synthetic absorbable lacrimal plugs provide approximately **6 months of treatment.**



Months
OF RELIEF FROM DRY EYE

- Provides extended temporary occlusion lasting approximately **180 days**
- Ideal for treatment of **post-surgical dry eye**, and to determine potential effectiveness of a non-absorbable punctal plug
- Also indicated for use in treating the dry eye components of various **ocular surface diseases**, including contact lens intolerance

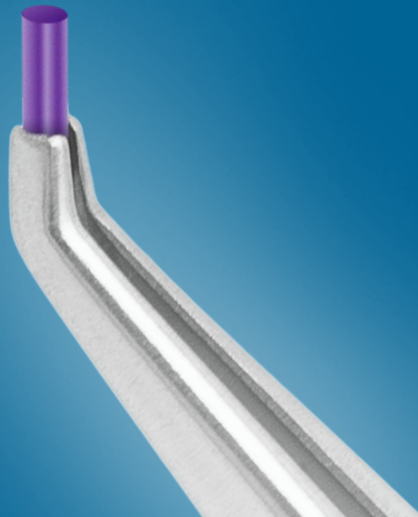

Vera180 Synthetic Absorbable Lacrimal Plugs

Synthetic absorbable lacrimal plugs made of poly-p-dioxanone (PDO). Absorbs in approximately 180 days.

20 PLUGS PER BOX (10 packs of 2 plugs each)

SKU		SIZE
ESK-1002	Vera180 Synthetic Absorbable Lacrimal Plugs (10 Pairs)	0.2mm
ESK-1003	Vera180 Synthetic Absorbable Lacrimal Plugs (10 Pairs)	0.3mm
ESK-1004	Vera180 Synthetic Absorbable Lacrimal Plugs (10 Pairs)	0.4mm
ESK-1005	Vera180 Synthetic Absorbable Lacrimal Plugs (10 Pairs)	0.5mm

2 PLUGS PER BOX

SKU		SIZE
ESK-1002S	Vera180 Synthetic Absorbable Lacrimal Plugs (Single Pair)	0.2mm
ESK-1003S	Vera180 Synthetic Absorbable Lacrimal Plugs (Single Pair)	0.3mm
ESK-1004S	Vera180 Synthetic Absorbable Lacrimal Plugs (Single Pair)	0.4mm
ESK-1005S	Vera180 Synthetic Absorbable Lacrimal Plugs (Single Pair)	0.5mm

Temporary Punctal Occlusion



VeraC7™

Temporary Collagen Inserts lasting **7 to 10 days**

- Ideal for **diagnostic use** in chronic dry eye patients considering permanent punctal occlusion
- Also indicated for extending medication contact time and effectiveness

VeraC7 Collagen Inserts

Collagen punctal inserts for diagnostic use, providing highly effective occlusion in the first 2 to 3 days post-insertion. Absorbs completely in 7 to 10 days. 60 inserts per box (10 packs of 6 inserts each).

SKU		SIZE
CSP-1002	VeraC7 Collagen Inserts (60 inserts)	0.2mm
CSP-1003	VeraC7 Collagen Inserts (60 inserts)	0.3mm
CSP-1004	VeraC7 Collagen Inserts (60 inserts)	0.4mm

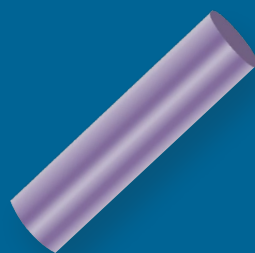

Vera90™

Synthetic Extended Inserts lasting **60 to 180 days**

- Ideal for the treatment of **dry eye following LASIK** or other surgical procedures
- Also indicated for use in treating the dry eye components of various ocular surface diseases

Vera90 Synthetic Extended Inserts

Synthetic extended punctal inserts made of E-Caprolactone-L-Lactide copolymer (PCL). Absorbs in 60 to 180 days. 20 inserts per box (10 packs of 2 inserts each).

SKU		SIZE
ESP-1002	Vera90 Synthetic Extended Inserts (10 pairs)	0.2mm
ESP-1003	Vera90 Synthetic Extended Inserts (10 pairs)	0.3mm
ESP-1004	Vera90 Synthetic Extended Inserts (10 pairs)	0.4mm
ESP-1005	Vera90 Synthetic Extended Inserts (10 pairs)	0.5mm

Dry Eye Diagnostics



BioGlo™

Fluorescein ophthalmic strips for evaluating contact lens fittings, corneal and conjunctival problems and applanation tonometry. CE marked. 100 or 300 individually wrapped sterile strips per box.



Lissamine Green

Ophthalmic test strips for evaluating corneal and conjunctival problems. Unlike Rose Bengal, it is sting-free. 100 individually wrapped sterile strips per box.



TearFlo™

Schirmer-type tear test for measuring and recording tear volume. CE marked. 100 individually wrapped sterile strips per box.

Miscellaneous



Dry Eye Compress

LAC-1000

Featuring HydroHeat™ technology to provide clean, deep-penetrating, moist heat. Microwave for 30 seconds and apply 3-5 minutes a day to relieve dry eye and improve meibomian gland function, or freeze and apply cold to relieve swollen, puffy eyes.



Instruments

Stephens Intracanalicular Plug Forceps

S5-1059

For use in removal of punctal plugs and insertion of collagen and synthetic extended inserts.



Gland Expressor

S5-1057

88mm forceps with closee paddles for use in the expression of the meibomian gland.

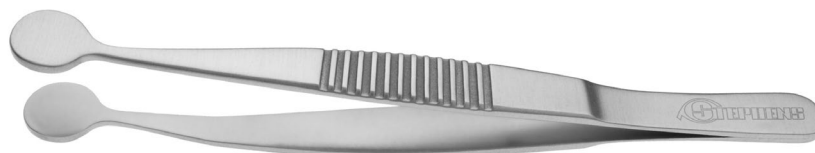

Stephens Meibomian Gland Compressor

S5-1058

Overall length 105mm, paddle length 3.25mm
For use in the compression of the meibomian gland.



Sizing Gauge

S8-1200/S8-1205

0.5mm/0.6mm and 0.7mm/0.8mm for determining the proper size punctal occluder prior to insertion.





Speculums	202
Foreign Body, Curette	203
Manipulator, Hook, Caliper	203
Forceps	205
Needle Holder, Scissors	207
Knives	209

Single-Use



Barraquer Wire Speculum

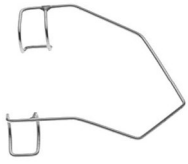

SSD1 1001

Infant, 4mm
Overall Length: 32mm

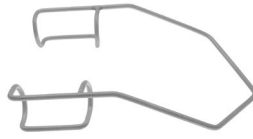

SSD1 1002

Child, 12mm
Overall Length: 39mm

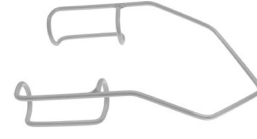

SSD1 1005

Adult, 15mm
Overall Length: 41mm

Barraquer Wire Speculum

Solid Blades

SSD1 1010 Child, 12mm

Overall Length: 35mm

SSD1 1015 Adult, 15mm

Overall Length: 42mm



Kratz Wing Speculum

SSD1 1016

Overall Length: 38mm
Adult, 15mm

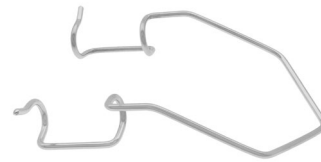

Lieberman Adjustable Speculum

SSD1 1026

Overall Length: 82mm
15mm



Lancaster Speculum

SSD1 1070

Overall Length: 85mm
15mm



Desmarres Lid Retractor

SSD1 1220 #1, 13mm

Overall Length: 133mm

SSD1 1225 2.5mm

Overall Length: 144mm



Golf Club Foreign Body Spud

SSD2 1135

Overall Length: 117mm

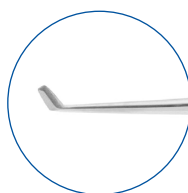

Chalazion Curette

SSD4 1005 1.75mm

Overall Length: 133mm

SSD4 1015 2.5mm

Overall Length: 131mm



Drysdale Nucleus Manipulator

SSD4 1068

Overall Length: 111mm

Paddle Shaped

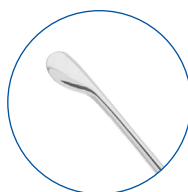

Maumenee-Barraquer

SSD4 1116

Overall Length: 120mm

Vitreous Sweep, Spatula



Schocket Scleral Depressor

SSD4 1231

Overall Length: 135mm



Lester Lens Manipulator

SSD4 1372

Overall Length: 114mm

Angled

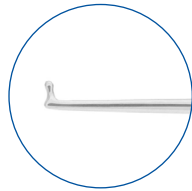

Sinskey II Lens Hook

SSD4 1387

Overall Length: 111mm

Angled



Strabismus Hook

SSD4 1443

Overall Length: 126mm



Braunstein Fixed Caliper

SSD4 1457

Overall Length: 67mm

3.5mm / 4.0mm



Nagahara Phaco Chopper

SSD4 1550

Overall Length: 112mm

Nucleus Splitter, Blunt Tip



Desmarres Chalazion Forceps

SSD5 1025

Overall Length: 91mm
20mm

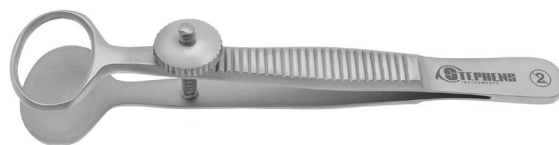

Barraquer Cilia Forceps

SSD5 1085

Overall Length: 108mm

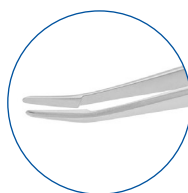

Barraquer Colibri Forceps

SSD5 1120

Overall Length: 70mm
Tying Platform, 0.12mm

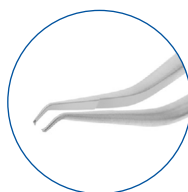

Bonn Forceps

SSD5 1240

Overall Length: 109mm
1x2 Teeth, 0.12mm

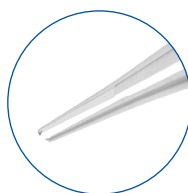

Masket Capsulorhexis Forceps

SSD5 1602

Overall Length: 105mm
Curved

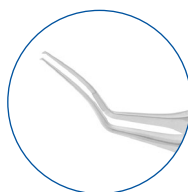

Utrata Capsulorhexis Forceps

SSD5 1603

Overall Length: 105mm

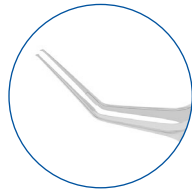

Jaffe Tying Forceps

SSD5 1625

Overall Length: 110mm

Smooth Jaws, 0.3mm

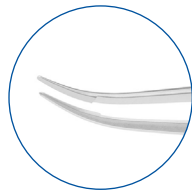

Kelman-McPherson Tying Forceps

SSD5 1630

Overall Length: 106mm

Smooth Jaws, Angled

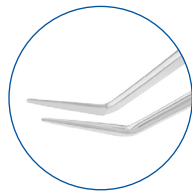

McPherson Tying Forceps

SSD5 1650

Overall Length: 111mm

Straight

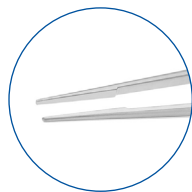

Jewelers Forceps #3C

SSD5 1700

Overall Length: 112mm#3C, Straight



Jewelers Forceps #5

SSD5 1710

Overall Length: 112mm



Castroviejo Needle Holder

SSD6 1050

Overall Length: 142mm

Standard Jaws, Straight

With Lock

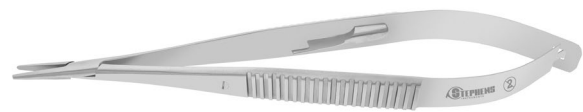

Castroviejo Needle Holder

SSD6 1070

Overall Length: 137mm

Delicate Jaws, Curved

Without Lock

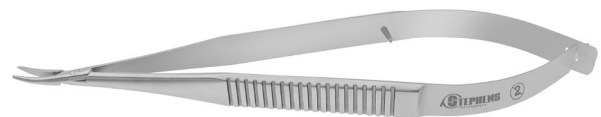

Stevens Tenotomy Scissors

SSD7 1085

Overall Length: 115mm

Straight



Castroviejo Corneal Scissors

SSD7 1240

Overall Length: 117mm

Medium Blades, Curved, Blunt

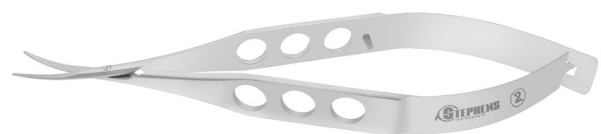

Westcott Tenotomy Scissors

SSD7 1325

Overall Length: 115mm
Standard Blades, Blunt



Vannas Capsulotomy Scissors

SSD7 1370

Overall Length: 82mm
Straight, Sharp



Vannas Capsulotomy Scissors

SSD7 1375

Overall Length: 84mm
Curved, Sharp



Castroviejo Lacrimal Dilator

SSD8 1015

Overall Length: 137mm
Medium & Fine Tips



Bowman Lacrimal Probe

SSD8 1070

Overall Length: 153mm
00-0



Knives

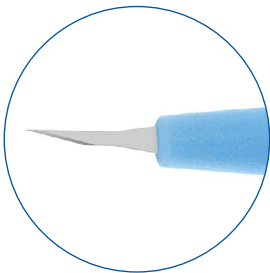

R-1500

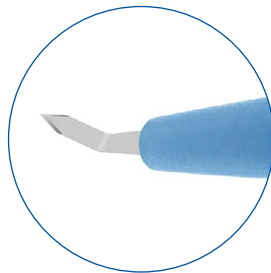

R-5508

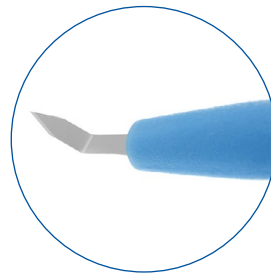

R-5516

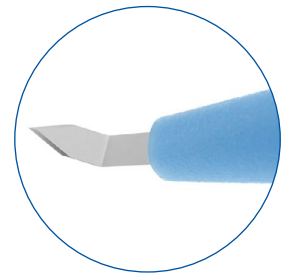

R-5570

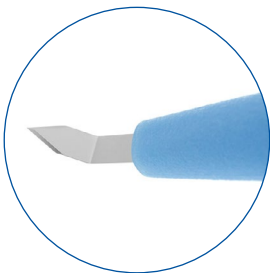

R-5572

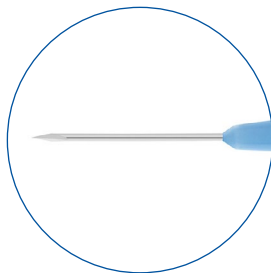

R-5560

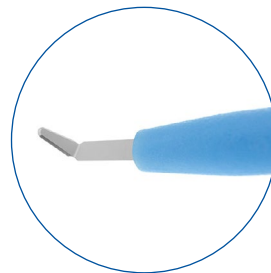

R-9402

KNIVES

R-1500	15 Degree Stab Knife	6 per box
R-5508	2.2mm Angle Slit Knife	6 per box
R-5516	2.8mm Angle Slit Knife	6 per box
R-5570	3.0mm Angle Slit Knife	6 per box
R-5572	3.2mm Angle Slit Knife	6 per box
R-5560	20ga Full Handle MVR Knife	6 per box
R-9402	Crescent Angled Bevel Up Knife	6 per box

- A**
- Adjustable Speculum..... 5–7
 - Adson Forceps..... 60
 - Aebli Angular Scissors..... 94
 - Agricola Retractor 12
 - Air Injection Cannula..... 122
 - Akahoshi Pre-Chop 80–81
 - Alfonzo Speculum..... 7
 - Alger Brush..... 16
 - Anis Ball Tip Manipulator..... 42
 - Anterior Chamber Cannula..... 114, 116
 - Arruga Capsular Forceps 64
 - Arruga Retractor 28
 - Artisan Lens Implantation Forceps..... 77
 - Asymmetrical Forceps..... 144, 146
 - Atkinson Retrobulbar Needle..... 122
 - Ayer Chalazion Forceps..... 46
 - Azar Corneal Scissors 99
- B**
- Baby Jones Towel Clamp..... 81
 - Backhaus Towel Clamp..... 81
 - Bailey Infant & Child Lacrimal Cannula 119
 - Baird Chalazion Forceps 46
 - Baker Orbital Retractor Set..... 29
- BARRAQUER**
- Cilia Forceps..... 50, 136, 205
 - Colibri Forceps..... 51, 53, 205
 - Conjunctiva Forceps..... 59
 - Iris Scissors 101, 103–104
 - Iris Spatula..... 20, 23, 203
 - Lenticular Spoon 24
 - Needle Holder 85–86, 90–91, 140–141
 - Speculum..... 4–6, 202
- Beaupre Cilia Forceps..... 50
 - Beaver Blade Handle..... 129
 - Bechert Nucleus Rotator..... 21, 134
 - Berke Ptosis Forceps..... 46
 - Berkeley Double Marker..... 112
 - Beyer Rongeur Forceps..... 83
 - Bi-Manual Handpiece 113
 - Binkhorst Irrigating Hooked Cannula 123
 - Binkhorst Lens Forceps 75
- BISHOP-HARMON**
- Anterior Chamber Irrigator Cannula..... 114
 - Forceps 60
 - Iris Forceps..... 59, 137
- Blade Handle..... 129
 - Blaydes Lens Forceps 75
 - Bock Suture Forceps 66
- Bonaccolto Utility & Splinter Forceps..... 79
 - Bonaccolto Utility Forceps..... 83
- BONN**
- Forceps 56, 70, 137, 205
 - Iris Hook..... 30, 39
 - Lacrimal Cannula..... 119
- Bores Axis Marker..... 112
 - Bores Incision Spreading Forceps 79
 - Bores Radial Marker..... 110
 - Bores U-Shaped Fixation Forceps 64
 - Botvin Forceps..... 57
 - Bowman Lacrimal Probe..... 108, 208
 - Bracken Irrigating Cannula..... 114
 - Bracken Scleral-Fixation Forceps..... 64
 - Braunstein Fixed Caliper..... 39, 204
 - Bunge Evisceration Spoon 27
 - Buratto Flap Protector 44, 135
 - Buratto LASIK Flap Forceps..... 65
 - Buratto LASIK Irrigation Cannula..... 127
 - Burch Fixation Pick..... 30
- C**
- Caliper..... 39, 135, 204
- CANNULA**
- Air Injection 122
 - Anterior Chamber 114, 116
 - Aspirating..... 117–119, 128
 - Bi-Manual..... 113
 - Capsule Polisher 123–125
 - Cortex 124
 - Cystotome 122–123
 - DALK..... 129
 - Hydrodissector 126–127
 - Infusion Handpiece 116
 - Iris Retractor..... 124
 - Irrigating 114–115, 117–118, 122–123, 125, 127–129
 - I/A Handpiece 124–125
 - Lacrimal 119–121
 - LASIK..... 127–129
 - Retrobulbar 122
- CAPSULE**
- Elevator/Manipulator 21, 26
 - Forceps 64–65, 68–69
 - Polisher..... 19, 123–125
 - Punch 17
 - Scissors..... 104–105
- CAPSULORHEXIS FORCEPS**
- Forceps 68–70, 138–139, 205–206
 - Inamura Forceps 69, 138
 - Masket Forceps 68, 138, 205
 - Utrata Forceps 68, 138, 145, 206

CASTROVIEJO

Blade Breaker	17
Caliper	39, 135
Capsular Forceps.....	65
Colibri Forceps.....	52, 137
Corneal Scissors	96–100, 207
Cyclodialysis Spatula	24, 134
Keratoplasty Scissors.....	101
Lacrimal Dilator	106, 208
Needle Holder	86–88, 90, 141, 207
Spatula & Spoon.....	25
Speculum.....	8–9
Suturing Forceps.....	67, 138
Synechia Spatula.....	23

CHALAZION

Curette.....	18–19, 203
Forceps	46–49, 136, 205

CHANG

Combination Chopper.....	42
Horizontal Microfinger Chopper	42
Hydrodissection Cannula	126
Chang-Seibel Chopper	41

Chopper.....	40–42, 45, 204
--------------	----------------

Cilia Forceps.....	50, 136, 205
--------------------	--------------

Citelli Rongeur Forceps.....	83
------------------------------	----

CLAMP

Ptosis.....	46
Putterman	79
Towel.....	81

Clark Universal Speculum	8
--------------------------------	---

Cohan Corneal Forceps.....	54
----------------------------	----

Cohan-Vannas Scissors.....	106
----------------------------	-----

Colibri Forceps.....	51–53, 136–137, 205
----------------------	---------------------

CONJUNCTIVA

Clamp.....	79
Forceps	59
Scissors	101–102

Connor Wand	42
-------------------	----

Cook Speculum	8
---------------------	---

CORNEAL

Bi-Fixation.....	63
Corneal Epithelium Spatula	45
Forceps	53–55, 63, 84, 146
Knife.....	14
Scissors	96–100, 106, 207

Corneal Epithelium Spatula-Hockey Stick	45
---	----

CORNEOSCLERAL

Forceps	54
Punch.....	18

Cortical Cleaving Hydrodissection Cannula	126
---	-----

Crescent Angled Bevel Up Knife.....	209
-------------------------------------	-----

Cross-Action Lens Folding Forceps.....	76
--	----

Culler Iris Spatula	20
---------------------------	----

Culler Rectus Muscle Hook	37
---------------------------------	----

Curette.....	18–19, 203
--------------	------------

Cystotome Irrigation Cannula	122
------------------------------------	-----

D**DALK**

DALK Cannula	129
--------------------	-----

DALK Scissors	96
---------------------	----

Dastoor Pupil & Iris Repositor	24
--------------------------------------	----

Dastoor Superior Rectus Forceps	65
---------------------------------------	----

Depressor.....	28, 204
----------------	---------

DESMARRES

Chalazion Forceps.....	47, 136, 205
------------------------	--------------

Lid Retractor.....	11, 203
--------------------	---------

Diffenbach Serrefine	82
----------------------------	----

Dilator.....	106–107, 208
--------------	--------------

Dimarco Lens Folding-Insertion Forceps	78
--	----

Dix Foreign Body Spud.....	15
----------------------------	----

DMEK

Endothelium Forceps.....	55
--------------------------	----

Tissue Prep Forceps.....	71
--------------------------	----

Dodick Nucleus Cracker.....	79, 80
-----------------------------	--------

Dodick Nucleus Pre-Splitter	80
-----------------------------------	----

Dolmetsch Ptosis Clamp.....	46
-----------------------------	----

Double Ended Femtosecond Spatula.....	45
---------------------------------------	----

Dressing Forceps.....	60
-----------------------	----

DRY EYE

Compress Mask.....	198
--------------------	-----

Silicone Punctal Plugs	188–193
------------------------------	---------

Temporary Punctal Plugs.....	194–197
------------------------------	---------

Drysdale Nucleus Manipulator.....	21, 203
-----------------------------------	---------

DSAEK Corneal Forceps.....	146
----------------------------	-----

E

Eckhardt End Gripping Forceps	146
-------------------------------------	-----

Ellis Foreign Body Spud.....	15
------------------------------	----

Elschnig Cyclodialysis Spatula.....	24
-------------------------------------	----

Elschnig Fixation Forceps	63
---------------------------------	----

Endothelial Stripper.....	44
---------------------------	----

Entropion Forceps.....	47
------------------------	----

ENUCLEATION

Scissors	95–96
----------------	-------

Spoon	27
-------------	----

Erhardt Lid Forceps.....	48
--------------------------	----

- F**
- Fasanella Lacrimal Cannula 119
- Fascia Needle 14
- FEMTO**
- Chopper 45
- Spatula 45
- LRI Enhancement Forceps 66
- Fenzl Lens Manipulating Hook 32, 34
- Fenzl Lens Manipulator 33
- Fink Retractor 13
- Fischer-Arlt Iris Forceps 59
- FIXATION**
- Forceps 61, 84
- Hook 29, 61–64
- Pick 30
- Ring 11, 134
- FlexFit Punctal Plug 188–189
- Flieringa Fixation Ring 11
- FORCEPS**
- Asymmetrical 144, 146
- Bi-Fixation 63–64
- Capsule 64–65, 68–69
- Capsulorhexis 68–70, 138–139, 205–206
- Chalazion 46–49, 136, 205
- Cilia 50, 136, 205
- Colibri 51–53, 136–137, 205
- Conjunctiva 59
- Corneal 54–55
- Dressing 60
- Entropion 47
- Fixation 61–64
- Foreign Body 79
- Hemostat 81
- ILM 144, 146
- Incision Spreading 66, 79
- Intraocular / IOL 75–78, 140
- Iris 57–59, 61, 137, 205
- Jewelers 74–75, 206–207
- LASIK 65–66
- Lens 75–78
- Lid 48
- Meibomian Expressor 48
- Mosquito 81
- Muscle 78–79
- Nucleus 69, 79–81
- Plug 49, 66
- Pre-Chop 80–81, 140
- Ptosis 46
- Retinal 144–147
- Rongeur 83
- Suturing 66–67, 69–73, 138–140, 206
- Superior Rectus 65, 137
- Tissue 60–61, 71, 84
- Titanium 136–140
- Tying 56, 60, 67, 69–73, 138–140, 206
- Utility 56, 79–83
- FOREIGN BODY**
- Burr 16
- Forceps 79
- Needle 15
- Spud 15–16, 203
- Francis Chalazion Forceps 47, 136
- Francis Foreign Body Spud 15
- Fugo Z-Hook Lens Manipulator 33
- Fukasaku Lasik Spatula 43
- G**
- Galand Lens Manipulating Hook 35
- Galin Lens Spatula 22
- Gaskin Fragment Forceps 68
- Gass Punch 18
- Gill Corneal Knife 14
- Gill Iris Forceps 57
- Gills Colibri Forceps 51
- Gills Irrigating Cannula 114
- Gills Vannas Scissors 105
- Gills/Welsh Lens Loop 25
- Gills-Welsh Curette 19
- Gimbel Lasik Irrigation Cannula 127
- Gimbel Lasik Polishing Cannula 128
- Gimbel Nucleus Spatula 20
- Girard Corneoscleral Forceps 54
- Girard Synechia Spatula 22
- Goldstein Retractor 12
- Golf Club Foreign Body Spud 15, 203
- Gradle Cilia Forceps 50
- Graefe Fixation Forceps 61
- Graefe Iris Forceps 57
- Graefe Muscle Hook 36
- Graether Collar Button 30
- Graether Collar Button Iris Retractor Cannula 124
- Grandon T-Incision Marker 111
- Grandon-Barraquer Speculum 6
- Grayson/Kuglen Double-Ended Manipulator 32
- Green Fixation Forceps 62
- Green Muscle Hook 38
- Green Spatula 38
- Guimaraes LASIK Spatula 42
- Gulani Lasik Cannula 128
- Gunderson Muscle Forceps 79
- Guyton-Park Speculum 10

H

Haab Scleral Knife	14
Harms Colibri Forceps.....	52
Harms Trabeculotomy Probe	106
Harms Tying Forceps.....	69
Harris-Sinsky Lens Hook.....	33
He Hook Chopper	41
Healon Aspirating Cannula.....	117
Heart-Shaped Vectis Irrigation Cannula	115
Heath Chalazion Forceps.....	48
Hemostat.....	81

HENDERSON

Degree Gauge.....	113
LRI Axis Marker	113
Pre-Operative Alignment Marker.....	112
Toric IOL Marker	113
Hersch Lasik Flap Positioner Cannula.....	128
Herzing LASIK Elevator/Retractor	43
Hess Iris Forceps.....	58
Hirschman Iris Hook.....	31
Hirschman Irrigating Cannula.....	114
Hirschman Lens Spatula	22
Hoffer-McPherson Corneal Bi-Fixation Forceps	63
Hoffer-McPherson Corneal Forceps.....	55
Hoffman-Polack Corneal Bi-Fixation Forceps.....	63
Holth Capsular Punch	17

HOOK

Fixation	29
Iris.....	29–32, 39, 135
Lens	31–35, 135
Muscle	36
Scleral	29
Strabismus.....	38
Tenotomy	36
Utility.....	38, 44
Horizontal Cutting Scissors.....	147
Humer Lens Folding Forceps.....	77, 140
Hunt Chalazion Forceps	48
Hyde Corneal Forceps.....	54
Hydrodissection Cannula	126–127

I

ILM Peeling Forceps	144, 146
Inamura Capsulorhexis Forceps.....	69, 138
Infusion Hand Piece	116
IOL Cutting Scissors.....	147
IOL Holding Forceps.....	146

IRIS

Cannula	124
Forceps	57–59, 61, 137, 205
Hook.....	29–32, 39, 135

Scissors	91–93, 103–104
Spatula.....	20, 134

Irrigation Cannula	113–115, 118, 122, 125, 127
--------------------------	-----------------------------

J

J Shaped Hydrodissector.....	127
Jacobi Aspirating & Irrigating Cannula.....	118
Jaeger Lid Plate.....	12

JAFFE

Lens Spatula	23
Needle Holder	88
Stitch Scissors	103
Tying Forceps.....	70, 206
Wire Retractor	11
Jaffe-Maltzman Lens Hook	35
Jameson Muscle Forceps	78
Jameson Muscle Hook.....	37
Jensen Posterior Capsule Polisher	123
Jervey Iris Forceps	61
Jewelers Forceps.....	74–75
Josephberg-Besser Scleral Depressor.....	28

K

Kalt Needle Holder.....	88
Kansas Nucleus Bisector	40
Kansas Nucleus Fragment Forceps	69
Kansas Nucleus Trisector	40
Katzen LASIK Flap Unzipper.....	44, 135
Katzin Miniature Scissors.....	100
Keislar Lacrimal Cannula.....	119
Kelly Descemet Membrane Punch	18
Kelman Cystotome Knife Cannula	123
Kelman Lens Holding & Manipulating Forceps	76
Kelman-McPherson Forceps	55
Kelman-McPherson Tying Forceps.....	70, 139
Kerichoff Aspiration & Irrigation Cannula	125
Kerrison Rongeur Forceps	83
Kimura Platinum Spatula	25
Kirby Expressor Hook & Loop.....	37
Kirby Intracapsular Lens Loop.....	26
Kirby Iris Spatula.....	20
Kirby Muscle Hook.....	37
Knapp Retractor.....	13
Knapp Strabismus Scissors.....	93, 95

KNIFE

Corneal.....	14
Disposable	209
Scleral	14
Knolle Irrigating Cannula.....	115
Knolle Micro Iris Hook.....	31
Knolle Nucleus Spatula	22
Knolle-Pearce Vectis Cannula.....	115

Koch Phaco Manipulator.....	22
Koch Stop And Chop Manipulator.....	40
Kraf Capsule Tag Forceps.....	68
Kratz Capsule Wall Scraper.....	124
Kratz Irrigating Cannula.....	115
Kratz Wing Speculum.....	6, 202
KU LASIK Flap Elevator/Manipulator.....	43
Kuglen Iris Hook & Lens Manipulator.....	31
Kuhnt Fixation Forceps.....	62

L**LACRIMAL**

Cannula.....	119–121
Dilator.....	106–107, 208
Probe.....	107–108, 208

LACRIVERA.....187

La-Force Foreign Body Spud.....	16
Lahey Chalazion Forceps.....	49
Lambert Chalazion Forceps.....	49
Lancaster Speculum.....	9, 202
Large Ring Scissors.....	92

LASEK/LASIK

Alcohol Well.....	112
Cannula.....	127–129
Elevator/Manipulator.....	43
Flap Forceps.....	65–66
Flap Protector.....	44, 135
Flap Retreatment.....	43–44, 136
Flap Unzipper.....	44, 135
Spatula.....	42–43
Speculum.....	4

LENS

Forceps Folding.....	76–77
Forceps Holding.....	75–77
Hook.....	31–35, 135
Loop.....	25–27, 134
Manipulator.....	21–22, 31–35, 135, 203–204
Spatula.....	22–23
Lester Fixation Forceps.....	62
Lester Lens Manipulator.....	32, 135, 204
Lester-Burch Speculum.....	9
Lewicky Lens Manipulating Hook.....	33
Lewis Lens Loop.....	26
LID	
Chalazion Forceps.....	46–49, 136, 205
Jaeger Plate.....	12
Retractor.....	4, 11, 203
LIEBERMAN	
Forceps.....	73
Speculum.....	5–7, 9, 134, 202
Livernois Lens Forceps.....	76

Loop, Lens.....	25–27, 134
Lordan Chalazion Forceps.....	49
LRI Gravity Marker.....	112
Lund Micro Keratoplasty Scissors.....	100

M

Macgregor Conjunctiva Forceps.....	59
Machet LASIK Retreatment.....	44
Mackool Iris Repositor.....	31
Maltzman-Fenzl Lens Manipulator Hook.....	34
Manhattan Eye & Ear Forceps.....	72

MANIPULATOR

Elevator.....	13, 43
Lens.....	21–22, 31–35, 135, 203–204
Nucleus.....	20–22, 35–36, 40–41, 134, 203–204
Phaco.....	22, 35, 41, 204
Manson Double Ended Hook.....	38

MARKERS

Axis.....	110, 113
Optical Zone.....	109–111
PRK.....	111
Radial.....	110
Toric.....	113

Masket Capsulorhexis Forceps.....	68, 138, 205
Maumenee Colibri Forceps.....	52–53
Maumenee-Barraquer Spatula.....	23, 203
Maumenee-Park Speculum.....	10
Maunoir Iris Scissors.....	93
Mccannel Iris Suture Needle Guide.....	38
Mccullough Utility Forceps.....	82
Mcguire Corneal Scissors.....	98

MCPHERSON

Forceps.....	55, 63, 70–71, 139, 206
Needle Holder.....	89
Scissors.....	101–102
Mcreynolds Spatula & Hook.....	38
Meibomian Gland Expressor.....	48
Mendez Axis Finder.....	110
Mendez LASIK Flap Forceps.....	66
Meyerhoefer Chalazion Curette.....	18
Microsurgical.....	142–147
Micro Gripping Forceps.....	145
Micro Needle Holder.....	90
Micro-Incision Capsulorhexis Forceps.....	139
MICS Capsulorhexis Forceps.....	70, 139
Miniature Corneal Scissors.....	97–98, 100
Moody Fixation Forceps.....	62
Morrison Lens Loop & Probe.....	26
Mosquito Hemostat.....	81
Muldon Lacrimal Dilator.....	106
Muller Retractor.....	12

- Muscle Forceps 78–79
Muscle Hooks..... 36–38
- N**
- NAGAHARA**
Disposable Phaco Chopper 204
Horizontal Chopper 40
- Nasal Speculum..... 14
Naugle-Fleming Knurled Dilator..... 107
Needle Driver..... 85–91
- NEEDLE HOLDER** 85–91
Needle Point Stitch Scissors 93
Nevyas Capsulorhexis Forceps..... 69
New Orleans Lens Loop 26, 134
Newell Lid Retractor, Pair..... 4
Nichamin Lasik Flap Positioner Cannula 128
Nichamin Quick Chop Verticle Chopper..... 40
Nightingale Curette 19
- NUCLEUS**
Cannula 126
Chopper 35–36, 41, 204
Cracker 79–80
Forceps 69
Manipulator 21, 40, 134, 203
Rotator 21, 134
Spatula..... 20–22
Splitter..... 35–36, 80
- O**
Obstbaum Synechiaie Spatula 23
O’Conner Tenotomy Hook..... 36
Oculoplastic Set..... 168
Open Ended Curette..... 19
Osher Nucleus Splitter 36
Osher Superior Rectus Forceps..... 65
Osher Utility Hook..... 44
Osher Y-Hook IOL Manipulator..... 35
- P**
Pallin Lens Spatula..... 23
Paton Double Spatula..... 25
Paton Tying Forceps 73
Paufigue Suture Forceps..... 72
Pearce J-Shaped Hydrodissector..... 127
Pearce Nucleus Hydrodissector 126
Pettigrove PRK Marker/Spatula 111
- PHACO**
Chopper 35, 41, 204
I/A Handpiece 125
Manipulator 22
Pre-Splitter..... 80
Splitter..... 35, 41
- Pierson Forceps..... 53–54, 84
Pigtail Probe..... 107
Pisacano Nucleus Rotator 21
Plastic Sterilization Tray..... 130–131
Polisher, Capsule..... 123, 125
Pre-Chop, Phaco 80–81, 140
- PROBE**
Lacrimal 108, 208
Trabeculotomy 106
- Protector, Flap 44, 135
Pterygium Brush 16
Ptosis Forceps..... 46
- PUNCH**
Corneoscleral..... 18, 54
Membrane 18
- Punctal Dilator 106–107, 208
Punctal Gauge..... 109
Punctal Plugs 186–187
Pupil Repositor 24
Putterman Muscle Conjunctival Clamp 79
- Q**
Quick Chop 40, 42
- R**
Radial Marker..... 110
Rainin Air Injection Cannula 122
Rainin Lens Hook 33
Reiss Corneoscleral Punch..... 18
Rentsch & Boat Hook & Lens Manipulator..... 34
Retinal 144
- RETRACTOR**
Iris..... 124
Lacrimal 12–13
Lid..... 4, 11–13, 203
Orbital 28–29
- Retreatment, LASIK..... 43–45, 136
Retrolubar Injection Cannula 122
Reverse Simcoe I/A Unit..... 125
Reverse Sinsky Hook 36
Ring, Fixation 11
Rolf Lacrimal Sac Probe 107
Rosen Phaco Splitter..... 41
Ruler 39
- S**
Sattler Muscle Forceps..... 78
Sauer Speculum 8
Sauer Suture Forceps..... 72
Sauter Nucleus Hydrodissector 126
Scheie Anterior Chamber Cannula 116
Schepens Orbital Retractor..... 28

- Schepens Scleral Depressor..... 28
 Schocket Scleral Depressor 28
- SCISSORS**
 Capsulotomy..... 104–105
 Conjunctiva 101–102
 Corneal..... 96–100
 DALK..... 96
 Eucleation 95–96
 Iris..... 91–93, 103–104
 Keratoplasty 101
 Retinal 144–147
 Stitch..... 93, 102–103
 Strabismus..... 93, 95
 Tenotomy 94, 101–105
 Utility..... 92
- Scleral Depressor 28, 204
 Scleral Hook 29
 Scleral Plug Forceps 66
- SEIBEL**
 Chopper 41
 Intralase..... 43, 45, 136
- Seipser Endocapsular Controller..... 21
 Serrated Gripping Forceps 145
 Serrefine Clamp..... 82
 Shahinian Cannula..... 125
 Shaws Needle Holder 91
 Sheets Irrigating Vectis Cannula 117
 Sheets Micro Hook..... 30
- SHEPARD**
 Forceps 72, 77
 Marker..... 109
- Shepard-Castro Corneal Scissors 100
 Shepard-Hoffer Optic Zone Marker w/ Cross Hairs 109
 Schocket Scleral Depressor 28, 204
 Silicone Bulb..... 114
- SIMCOE**
 Cannula 124–125
 Lens Loop..... 27
- Simpson Lacrimal Dilator 107
 Single-Use Instruments 200–209
- SINSKEY**
 Forceps 72
 Hook..... 34, 36
 Hydrodissector 126
 Titanium..... 135
- Skeel Chalazion Curette..... 19
- SLADE, LASIK**
 Cannula 127
 Flap Spatula..... 43
- Retreatment 43
 Speculum..... 4
- Slit Knife..... 209
 SMILE Double Ended Dissector 45
 Snellen Lens Loop 26
 Solomon Femto Chopper..... 45
- SPATULA**
 Cyclodialysis 24, 134
 Double-Ended..... 24–25, 38, 45
 Femtosecond 45
 Flap 42–43, 45, 136
 Iris..... 20, 134
 Lens 22–23
 Nucleus 20, 22
 SMILE 45
 Synechiae..... 22–23
 Vitreous..... 23, 203
- SPECULUM**
 Infant..... 4, 202
 Irrigating 7
 Nasal 5–6, 14
 Temporal 4–11, 134, 202
- SPOON**
 Eucleation 27
 Evisceration..... 27
 Lenticular 24
 Spoon & Spatula..... 25
- SPUD** 15–16, 203
 Stab Knife..... 209
- STEPHENS**
 Stephens A/C Maintainer..... 124
 Stephens Bi-Fixation Forceps..... 63–64
 Stephens Bi-Manual Handpiece 113
 Stephens Blade Breaker..... 17
 Stephens Capsulotomy Forceps..... 69
 Stephens Cilia Forceps..... 50
 Stephens Corneal Forceps..... 53
 Stephens DALK Scissors 96
 Stephens Eye Loop & Magnet..... 16
 Stephens Intracanalicular Plug Forceps..... 49
 Stephens Irrigating Speculum..... 7
 Stephens Lens Folding Forceps 76
 Stephens Lens Insertion Forceps..... 76
 Stephens Meibomian Gland Expressor 48
 Stephens Needle Holder 89, 141
 Stephens Phaco Nucleus Splitter 35
 Stephens Phaco Pre-Splitter 80
 Stephens Scissors 103
 Stephens Soft IOL Insertion Forceps..... 77, 140
 Stephens Toric IOL Bubble Level Marker..... 113
 Stephens Tying Forceps..... 73

- Stephens V-Shaped Wire Speculum 6
- Stephens-Gills Scissors..... 104
- Stephens-Vannas Scissors..... 104
- Stephens-Westcott Conjunctiva Scissors..... 102
- Sterilization Tray..... 130–131
- Stern-Gills Vannas Scissors..... 105
- Stevens Corneoscleral Forceps..... 54
- Stevens Tenotomy Hook 36
- Stevens Tenotomy Scissors..... 94, 207
- Stevenson Retractor..... 12–13
- STRABISMUS**
- Hook..... 38, 204
- Scissors 93, 95
- Suture Forceps 66–67, 69–73, 138–140, 206
- Swiss Blade Breaker 17
- Swiss Muscle Forceps..... 78
- T**
- TENNANT**
- Forceps 53, 73, 140
- Hook..... 35
- Nucleus Manipulator..... 21
- Titanium..... 140
- Tenzel Double Ended Periosteal Elevator 13
- Thornton Fixation Ring 11, 134
- Thornton Low Profile Marker..... 111
- Thorpe Corneal Forceps 55
- Thorpe Fixation Forceps 63
- Tissue Forceps 60–61, 71, 84
- TITANIUM**
- Caliper 135
- Capsulorhexis..... 138–139
- Flap..... 135–136
- Forceps 136–140
- Hook..... 134–135
- Manipulator 134–135
- Needle Holder 140–141
- Ring..... 134
- Spatula..... 134, 136
- Speculum..... 134
- Tooke Corneal Knife..... 14
- Towel Clamp 81
- Trays 130–131
- Trisector, Nucleus..... 40
- TROUTMAN**
- Alpha-Chymotrypsin Cannula 121
- Forceps 53, 65, 137
- Needle Holder 90–91
- Scissors 97, 100
- Trabeculotomy Probe 106
- Tying Forceps..... 56, 60, 67, 69–73, 138–140, 206
- Tyrell Iris Hook 29
- U**
- Universal Scissors..... 99
- Universal Speculum 5, 8
- Utility Forceps..... 56, 79–83
- Utrata Capsulorhexis Forceps 68, 138, 145, 206
- V**
- Vannas Capsulotomy Scissors..... 104–105, 208
- Vera180 Synthetic Absorbable Lacrimal Plugs 194–195
- Vera90 Synthetic Extended Inserts..... 197
- VeraC7 Collagen Inserts 196
- VeraPlug Punctal Plugs 190–191
- Vertical Cutting Scissors 144, 147
- Vidaurri LASIK Flap Irrigator..... 129
- W**
- Weaver Curette..... 19
- Weber Lens Loop..... 27
- Weil Infant Probing Lacrimal Cannula..... 121
- Wells Enucleation Spoon..... 27
- Welsh Flat Olive Tip..... 114
- West Irrigating Cannula 117
- West Lacrimal Cannula 121
- West Lacrimal Chisel 13
- WESTCOTT**
- Stitch Scissors 101–102
- Tenotomy Scissors..... 101–102, 208
- Wiese Chalazion Forceps 49
- Wilder Lacrimal Dilator..... 107
- Wilder Serrated Lens Loop..... 27
- Williams Lacrimal Bulbous Probe..... 108
- Williams Speculum..... 9
- Wills Eye Foreign Body Spud & Burr 16
- Wills Eye Irrigating Cannula 117
- Wills Hospital Utility Forceps..... 83
- Wills Retractor..... 13
- WIRE**
- Retractor..... 11
- Speculum..... 4–7, 134, 202
- Wright Fascia Needle..... 14
- XYZ**
- Ziegler Lacrimal Canal Probe..... 107

Our Commitment to Innovation

Do you have an innovative idea to develop and bring to life?

Stephens Instruments' design and development team is here to help.

Please contact info@stephensinst.com for more information.





No part of this catalog may be reproduced, edited, copied or disseminated in any form without prior written consent of Stephens Instruments.

Due to the constant technological progress all product specifications and illustrations are subject to change without notice.

VeraPlug™, SafeSite™, VeraPlug FlexFit™, etc. are trademarks of Stephens Instruments.



Stephens Instruments
2500 Sandersville Rd
Lexington KY 40511 USA
info@stephensinst.com

stephensinst.com

Toll Free (USA) **800.354.7848**